



PORTAIL

L'excellence **Made in France**

PORTAILS ALU ET PVC, UNE GAMME COMPLÈTE FABRIQUÉE EN FRANCE 



Les garanties GP PORTAIL

Garantie **25 ANS'**

Laquage **QUALICOAT, QUALIDECO, QUALIMARINE**, classe 2

PVC sans plomb garanti **10 ANS³**

Usine certifiée **ISO 9001**

Certifié Normes **EN 13241-1**

Engagement sur nos délais de livraison

Conception : GP PORTAIL - IV - 2021
Impression : Chevilon imprimeur - Sens

© Adobe stock, GP Portail, Somfy, USA, Epailon
Garde-corps : © Aurelien Brosini / Richard Sprang / Profils Systèmes
Illustrations, photos et couleurs non contractuelles

Papiers certifiés 100% PEFC. Promouvoir la gestion durable de la forêt.
Étice correspondant aux normes écologiques.

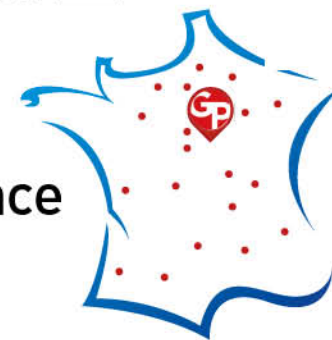

GP PORTAIL présent sur toute la France

Certifications, normes & labels

Label QUALICOAT classe 2

Ce label atteste de la qualité du processus de thermolaquage (épaisseur conforme de la couche de laque, adhérence, résistance mécanique, etc...)



Label QUALIDECO

Concerne les produits en aluminium thermolaqués ton bois.



Adhérent



Label QUALIMARINE

Le label QUALIMARINE concerne la préparation de surface des profilés en aluminium, avant laquage, pour les applications en atmosphères agressives.



25 ans de garantie sur la fabrication et le laquage

1- Nos produits sont garantis 25 ans contre les vices de fabrication d'assemblage, de montage et de tous profilés défectueux d'une utilisation normale. La motorisation, la quincaillerie, les fixations ont une garantie biennale ou une garantie constructeur par nos fournisseurs. Toute pose de portail avec une motorisation à venir devra obligatoirement faire l'objet de l'ajout de butte mécanique de fin de course pour que la garantie de fabrication du portail soit prise en compte. La garantie est limitée à la réparation ou au remplacement de la pièce défectueuse sous réserve que le litige ne provienne pas d'une mauvaise installation des produits. Le transport, la dépose et pose des produits ne sont pas compris dans la garantie. Toute réclamation fera l'objet d'une validation auprès de notre service technique pour la reconnaissance du défaut. Tous vices apparents ne sont pas pris en compte sous la garantie mais doivent faire l'objet de réserves sur le bon de livraison lors de la réception de la marchandise, puis l'envoi obligatoire d'une lettre en AR sous 48h à GP Portail, et au transporteur en lui indiquant les défauts constatés lors du déballage. Cette garantie couvre exclusivement les produits laqués contre les défauts suivants : cloquage, décollement, écaillage et certains types de corrosion, farinage, changement de teinte et perte de brillance supérieure aux tolérances des prescriptions du label Qualicoat / Qualimarine / Qualidéco. Et la non-conformité des produits à la commande et les vices cachés, provenant d'un défaut de matière, de conception ou de fabrication affectant les produits livrés et les rendant impropres à l'utilisation. (Voir conditions de garanties et exclusions sur notre site).

2- Tous nos produits font l'objet d'une garantie de 25 ans contre tous défauts de cloquage et farinage. Les produits devront être lavés chaque année au savon et rincés avec un chiffon doux.

3 - Notre fournisseur partenaire garantit 10 ans la fabrication de ses profilés PVC ainsi que leur tenue dans le temps.

Normes Européennes

Nos portails sont aux normes européennes homologués et validés par le **CSTB** pour l'ensemble de nos gammes avec automatisme.



FABRICANT LABELLISÉ PBS



Qualité et savoir-faire

Depuis 1972

Nos valeurs :

- le service client
- l'engagement
- la rigueur

Entreprise familiale depuis 1972

Personnalisation des portails sur mesure

Usine basée en Bourgogne

Certification ISO 9001

Contrôle qualité avant expédition

Tout nos portails sont contrôlés avant chaque expédition

Bureau d'études intégré

Banc d'essai



L'esprit de la performance

Sommaire

- P. 04 NOUVELLE COLLECTION
- P. 06 ALU DESIGN
- P. 20 ALU CLASSIQUE
- P. 28 ALU STYLE
- P. 36 PORTAILS AUTOPORTANTS
- P. 37 PVC
- P. 43 CLAUSTRAS
- P. 44 CLÔTURES PVC / ALU
- P. 48 GARDE-CORPS ET RAMPES
- P. 50 LA TECHNIQUE

- P. 50 LES COULEURS
- P. 51 TÔLES DÉCORATIVES, PERFORÉES, INSERT ALU
- P. 52 REMPLISSAGES
- P. 53 PROFILÉS / CACHE GOND
- P. 54 POTEAUX / TYPES D'OUVERTURES
- P. 54 ACCESSOIRES
- P. 56 MOTORISATIONS
- P. 58 TOUTES LES GAMMES
- P. 63 BOÎTE AUX LETTRES / NUMÉRO ALU



1^{ER} FABRICANT EUROPÉEN
à utiliser Hydro REDUXA 4.0

Hydro REDUXA – Billette

Meilleure de la classe → approche complète

1. Maximum ou en dessous de **4.0** kg CO₂/kg Aluminium
2. **VERIFIE** par DNV GL selon la norme ISO 14064
3. **CONFIRME** par une Déclaration Environnementale Produit (EPD/FDES)



Emissions de CO₂ de l'aluminium selon le pays

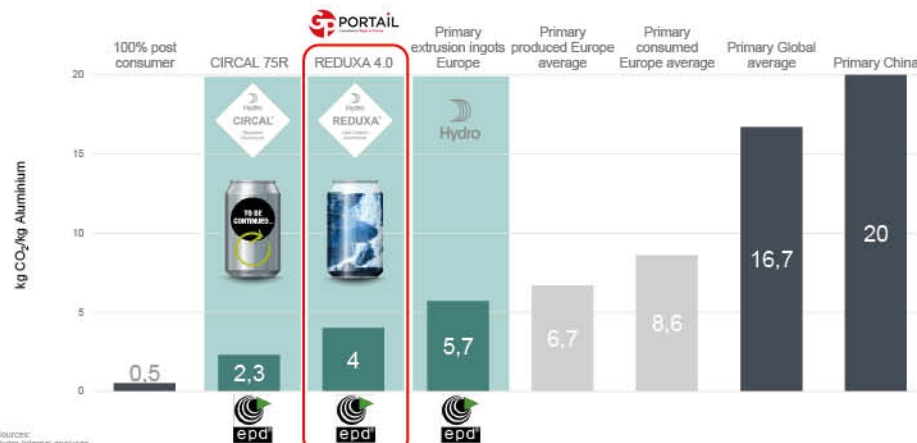

Sources:
Hydro internal analysis
European averages: BAA 2018
Global average: IAI 2018
China average: IAI 2017

*75% EOL Scrap + 10% Process Scrap + 15% Primary Ingot: 2.3 kg CO₂/kg 75R



À LA DÉCOUVERTE DES NOUVELLES TENDANCES, DES MOTIFS ET DES COULEURS *adaptés à votre maison*

L'esthétique s'invite à l'extérieur de la maison. Nos portails et clôtures s'harmonisent avec votre environnement.

GP PORTAIL crée pour vous des décors en aluminium brossé ou à la couleur du portail, perforés ou découpés. Découvrez notre nouvelle collection. Ces décors sont adaptables à tout nos portails.

Que vous recherchiez la sécurité, l'authenticité, la simplicité, l'élégance... Notre partenaire installateur saura vous conseiller et vous accompagner dans votre projet.





- Tôle décorative en aluminium, finition thermolaqué qualité extérieure qualicoat classe 2, à la couleur du portail. L'épaisseur de la tôle est de 3 mm, minimum. 13 teintes aux choix sans plus value.

- Tôle décorative personnalisable sur mesure.



1



2



3



4

Légendes

- 1 - TOLBIAC** : Portail TOLBIAC personnalisé, coulissant, insert alu à la vertical, clôture FOCH, remplissage vertical design, boîte aux lettres en harmonie.
- 2 - TOLBIAC** : Portail TOLBIAC 2 coulissant aspect 2 vantaux, insert alu remplissage horizontal design.

- 3 - MAGENTA** : battant, lames horizontales, décor « salamandre » insert alu brossé et PMMA, chiffre rétroéclairé
- 4 - FOCH** : Portail FOCH 1, battant, sans traverse, clôture FOCH et tôle décor. Boîte aux lettres en harmonie.
- 5 - ALÉSIA** : Portail ALÉSIA 4, remplissage vertical, décor alu

COLLECTION DESIGN

Notre collection DESIGN se personnalise à l'infini :

- plein
- ajouré
- barreau
- décor
- insert
- brise-vue

Ouvertures coulissantes ou battantes, forme droite.

ALU DESIGN



5

ALESIA 4

TOLBIAC

PORTAIL / PORTILLON



Ouvertures : battant 1 vantail / 2 vantaux - Couissant aspect 1 vantail / 2 vantaux

Remplissage : Horizontal / Vertical - Insert : Alu brossé adhésif face extérieure



BATTANT
COULISSANT
AUTOPORTANT

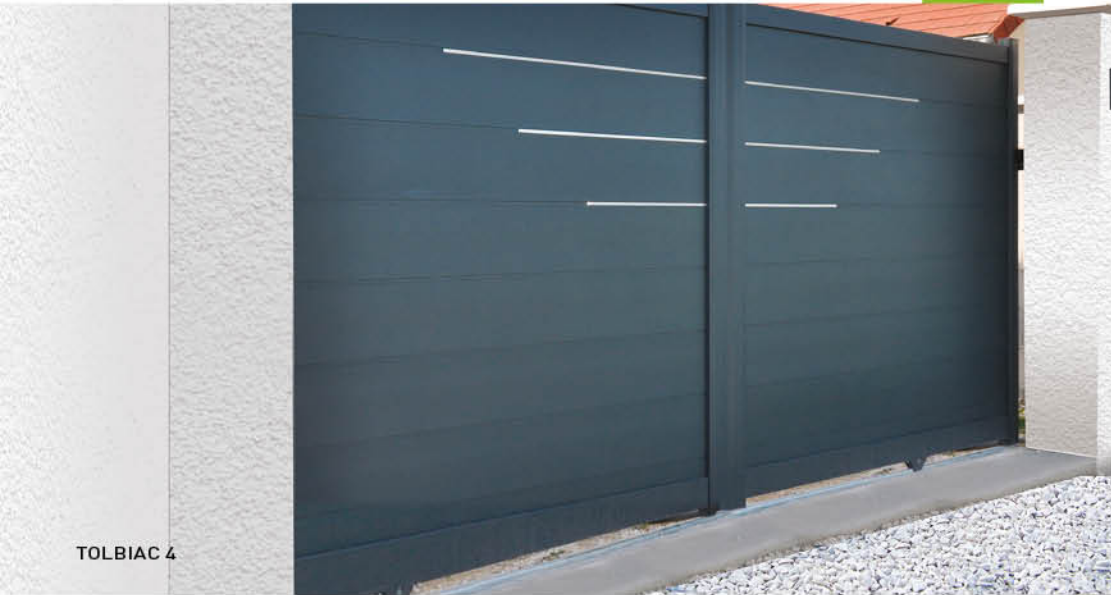

TOLBIAC 4

MABILLON

PORTAIL / PORTILLON



Ouvertures : 1 vantail / 2 vantaux / Couissant 1 vantail et aspect 2 vantaux

Barreaudage : Vertical / Horizontal / Tôles perforée / Brise vue pour le modèle 1 uniquement

Remplissage : Horizontal / Vertical



BATTANT
COULISSANT
AUTOPORTANT



MABILLON 7



PYRAMIDES

PORTAIL / PORTILLON

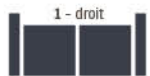

Barreaudage : Vertical / Horizontal / Tôles perforé

Ouvertures : 1 vantail / 2 vantaux / Coulissant 1 vantail (modèles 4, 5 uniquement) ou aspect 2 vantaux

Remplissage : Horizontal / Vertical

BATTANT
COULISSANT
AUTOPORTANT

+ DÉCOR

Vous pouvez remplacer les barreaux par de la tôle perforée



PYRAMIDES 3 Option Tôle décorative

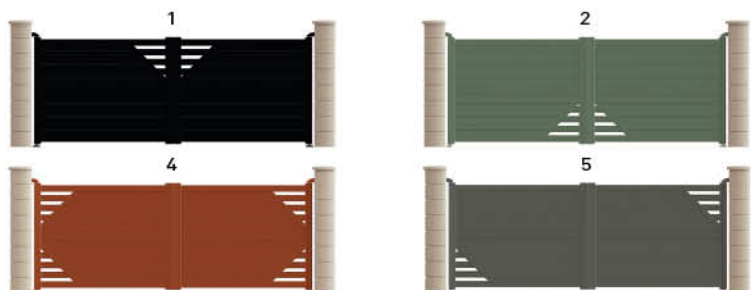

DUPLEIX

PORTAIL / PORTILLON



Ouvertures : 1 vantail / 2 vantaux / Coulissant 1 vantail et aspect 2 vantaux

Barreaudage : Vertical / Horizontal / Tôles perforée / Brise vue pour le modèle 1 uniquement

Remplissage : Horizontal / Vertical

BATTANT
COULISSANT
AUTOPORTANT

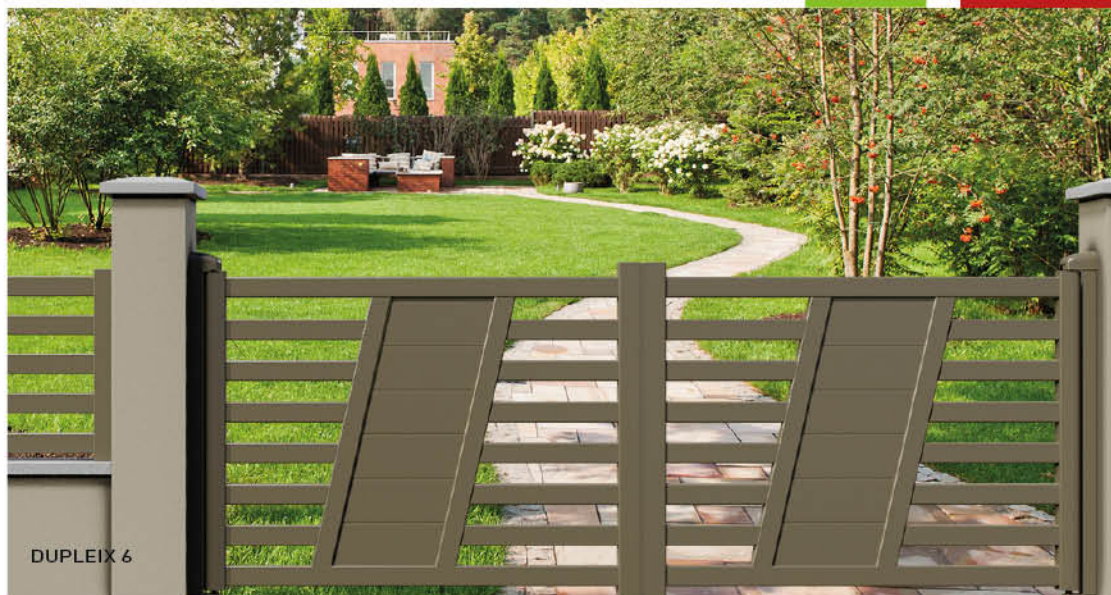

DUPLEIX 6



MAGENTA

PORTAIL / PORTILLON



Décor : Tôle perforée décorative (Images non contractuelles) - Voir page 51

Ouvertures : 1 vantail / 2 vantaux / Coulissant 1 vantail jusqu'à 3 m (modèles 1, 2, 3) ou aspect 2 vantaux

Remplissage : Horizontal / Vertical



BATTANT
COULISSANT
AUTOPORTANT

ALÉSIA

PORTAIL / PORTILLON



Décor : Insert aluminium brossé

Ouvertures : 1 vantail / 2 vantaux / Coulissant 1 vantail ou aspect 2 vantaux

Remplissage : Horizontal / Vertical / Insert alu brossé face extérieure

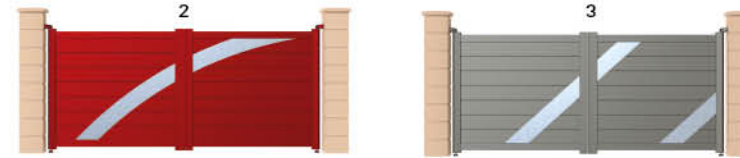

BATTANT
COULISSANT
AUTOPORTANT

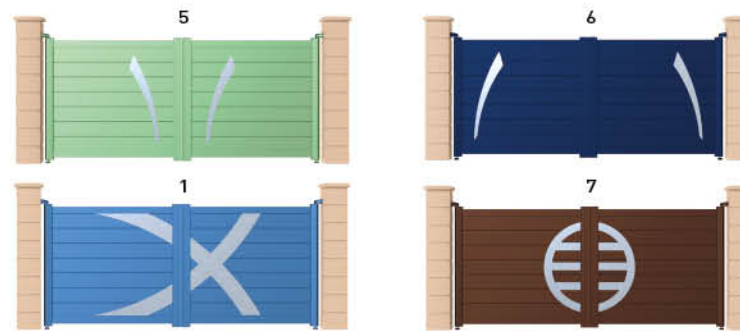

MIROMESNIL

PORTAIL / PORTILLON



Exclusivité
GP Portail

Décor : Hublot aluminium brossé - Voir page 51

Ouvertures : 1 vantail / 2 vantaux / Coulissant 1 vantail ou aspect 2 vantaux

Remplissage : Horizontal, lame alu brossé + hublots recto-verso

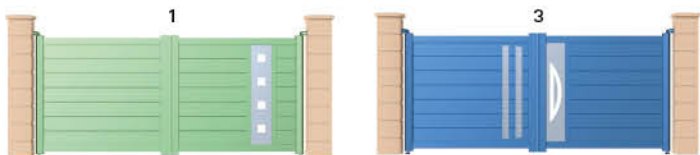

BATTANT
COULISSANT
AUTOPORTANT

CONCORDE

PORTAIL / PORTILLON



Exclusivité
GP Portail

Ouvertures : 1 vantail / 2 vantaux / Coulissant 1 vantail jusqu'à 3 ml, sur 2 vantaux au delà.

Remplissage : Tôle perforée décorative (Images non contractuelles)



ALU DESIGN



MIROMESNIL 2



CONCORDE 7



BATTANT
COULISSANT
AUTOPORTANT

TÔLE E

TÔLE C

TÔLE B

TÔLE G

BEL-AIR

PORTAIL / PORTILLON



Barreaudage : Vertical / Horizontal / Tôles perforée - Voir P.51 / Brise vue pour le modèle 1 uniquement

Ouvertures : 1 vantail / 2 vantaux / Coulissant 1 vantail ou 2 vantaux

Remplissage : Horizontal / Vertical



BATTANT
COULISSANT
AUTOPORTANT



BEL-AIR 4

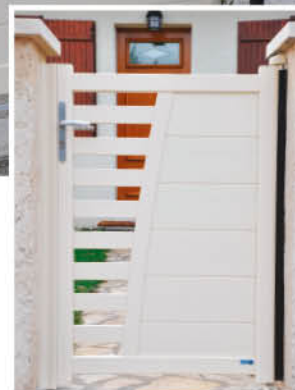

Portillon en harmonie
avec le portail

PASSY

PORTAIL / PORTILLON



Ouvertures : 1 vantail / 2 vantaux / Coulissant 1 vantail et aspect 2 vantaux

Barreaudage : Vertical / Horizontal / Tôles perforée Voir P.51 / Brise vue pour le modèle 1 uniquement

Remplissage : Horizontal / Vertical



BATTANT
COULISSANT
AUTOPORTANT



PASSY 4



COURCELLES

PORTAIL / PORTILLON



Ouvertures : 1 vantail / 2 vantaux / Coulissant 1 vantail (uniquement pour le modèle 1) et aspect 2 vantaux

Barreaudage : Vertical / Horizontal / Tôles perforée Voir P.51 / Brise vue pour le modèle 1 uniquement

Remplissage : Horizontal / Vertical

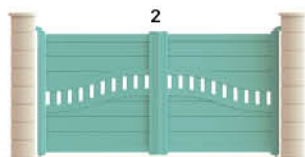
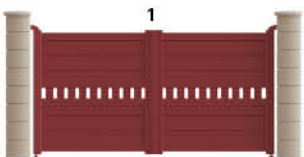

BATTANT
COULISSANT
AUTOPORTANT

PASTEUR

PORTAIL / PORTILLON



Ouvertures : 1 vantail / 2 vantaux / Coulissant 1 vantail et aspect 2 vantaux

Barreaudage : Vertical / Horizontal / Tôles perforée Voir P.51 / Brise vue pour le modèle 1 uniquement

Remplissage : Horizontal / Vertical

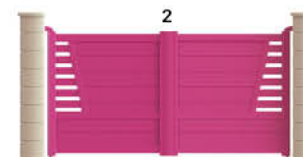

BATTANT
COULISSANT
AUTOPORTANT

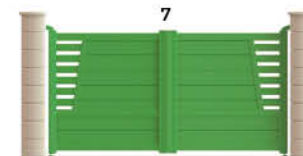
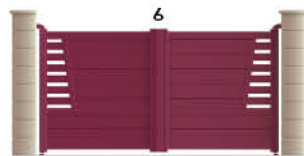
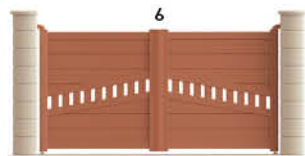
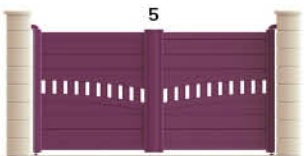
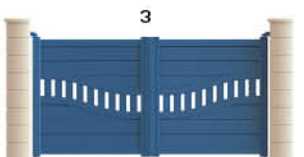

JASMIN

PORTAIL / PORTILLON



Ouvertures : 1 vantail / 2 vantaux / Couissant 1 vantail ou aspect 2 vantaux
Barreaudage : Vertical / Horizontal / Tôles perforée Voir P.51 / Brise vue pour le modèle 1 uniquement
Remplissage : Horizontal / Vertical

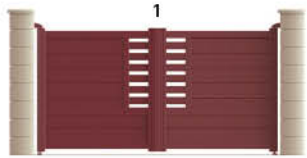

BATTANT
COULISSANT
AUTOPORTANT



JASMIN 4

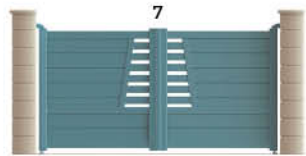
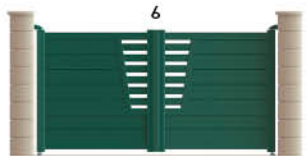
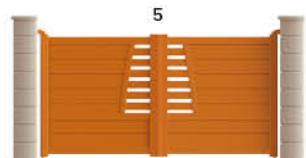

ODÉON

PORTAIL / PORTILLON

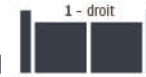

Ouvertures : 1 vantail / 2 vantaux / Couissant 1 vantail ou aspect 2 vantaux
Barreaudage : Vertical / Horizontal / Tôles perforée Voir P.51 / Brise vue pour le modèle 1 uniquement
Remplissage : Horizontal / Vertical

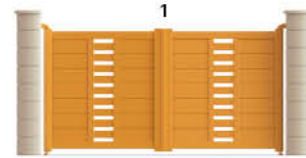

BATTANT
COULISSANT
AUTOPORTANT



ODÉON 5

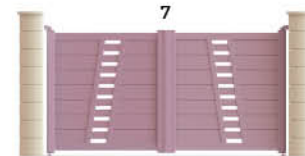
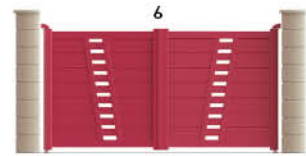
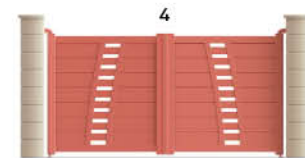
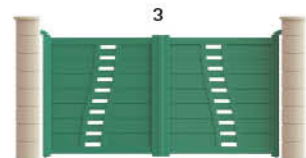

GAÎTÉ

PORTAIL / PORTILLON



Ouvertures : 1 vantail / 2 vantaux / Coulissant 1 vantail ou aspect 2 vantaux

Barreaudage : Vertical / Horizontal / Tôles perforée Voir P.51 / Brise vue pour le modèle 1 uniquement

Remplissage : Horizontal / Vertical

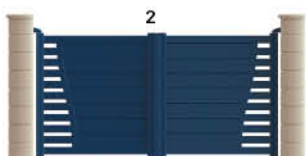

BATTANT
COULISSANT
AUTOPORTANT

VANNEAU

PORTAIL / PORTILLON



Ouvertures : 1 vantail / 2 vantaux / Coulissant 1 vantail ou aspect 2 vantaux

Barreaudage : Vertical / Horizontal / Tôles perforée Voir P.51 / Brise vue pour le modèle 1 uniquement

Remplissage : Horizontal / Vertical

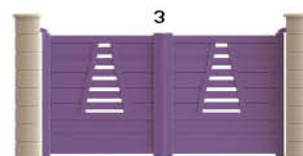
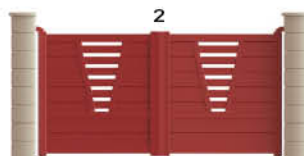

BATTANT
COULISSANT
AUTOPORTANT

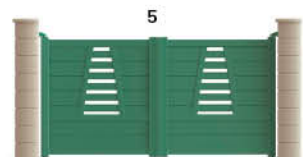
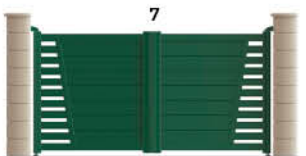
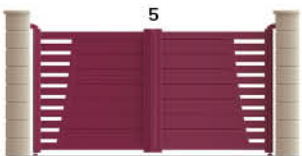

BOLIVAR

PORTAIL / PORTILLON



Ouvertures : 1 vantail / 2 vantaux / Coulissant 1 vantail ou aspect 2 vantaux

Barreaudage : Vertical / Horizontal / Tôles perforées Voir P.51 / Brise vue pour le modèle 1 uniquement

Remplissage : Horizontal / Vertical



BATTANT
COULISSANT
AUTOPORTANT



BOLIVAR 4

JUSSIEU

PORTAIL / PORTILLON



Ouvertures : 1 vantail / 2 vantaux / Coulissant 1 vantail ou aspect 2 vantaux

Barreaudage : Vertical / Horizontal / Tôles perforées Voir P.51 / Brise vue pour le modèle 1 uniquement

Remplissage : Horizontal / Vertical



BATTANT
COULISSANT
AUTOPORTANT



JUSSIEU 7



SÉGUR

PORTAIL / PORTILLON



Ouvertures : 1 vantail / 2 vantaux / Couissant 2 vantaux

Barreaudage : Vertical / Horizontal / Tôles perforées Voir P.51 / Brise vue pour le modèle 1 uniquement

Remplissage : Horizontal / Vertical

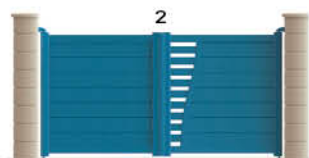
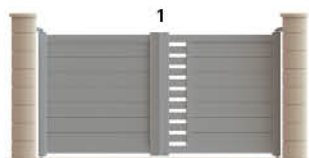

BATTANT
COULISSANT
AUTOPORTANT



SÉGUR 4

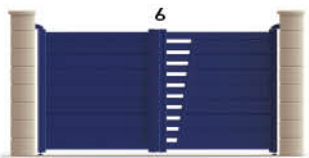
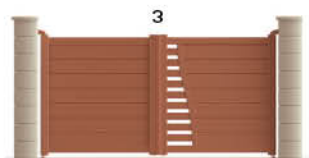

CARNOT

PORTAIL / PORTILLON



Ouvertures : 1 vantail / 2 vantaux / Couissant 1 vantail (uniquement pour le modèle 6 et 7) / 2 vantaux

Barreaudage : Vertical / Horizontal / Tôles perforées Voir P.51 / Brise vue pour le modèle 5 uniquement

Remplissage : Horizontal / Vertical

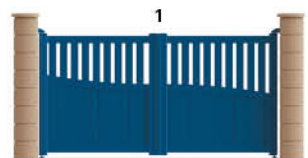

BATTANT
COULISSANT
AUTOPORTANT

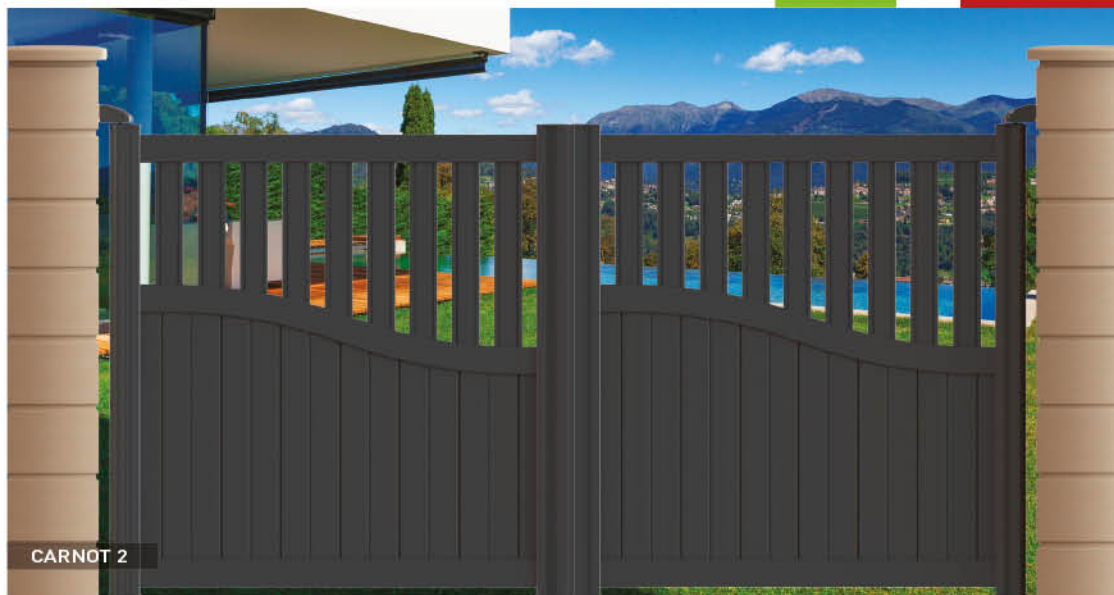

CARNOT 2

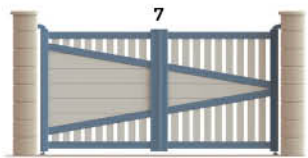
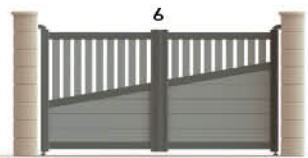

RASPAIL

PORTAIL / PORTILLON



Ouvertures : 1 vantail / 2 vantaux / Coulissant 1 vantail ou 2 vantaux

Barreaudage : Vertical / Horizontal / Tôles perforée Voir P.51 / Brise vue pour le modèle 1 uniquement

Remplissage : Horizontal / Vertical

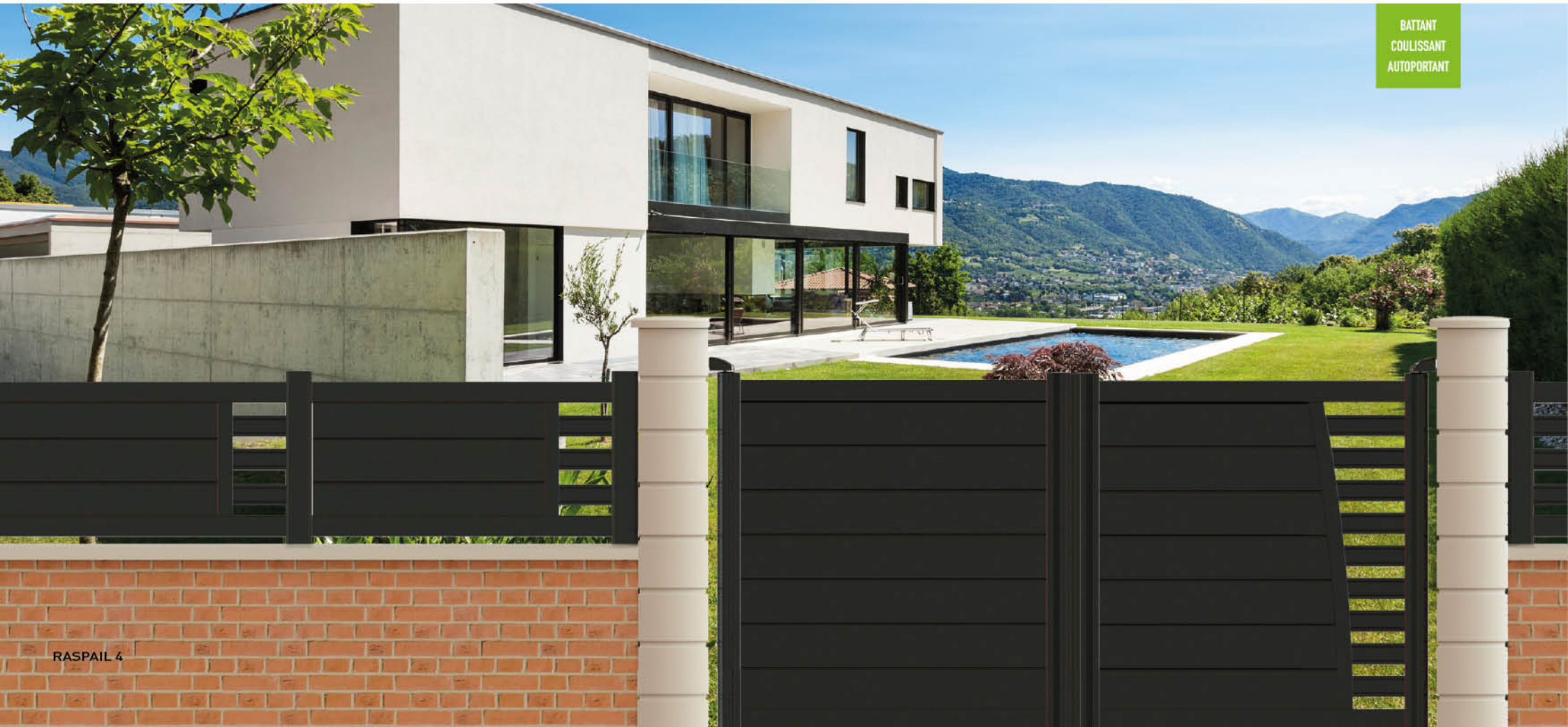

BATTANT
COULISSANT
AUTOPORTANT

RASPAIL 4



RASPAIL 4 COULISSANT



1



2

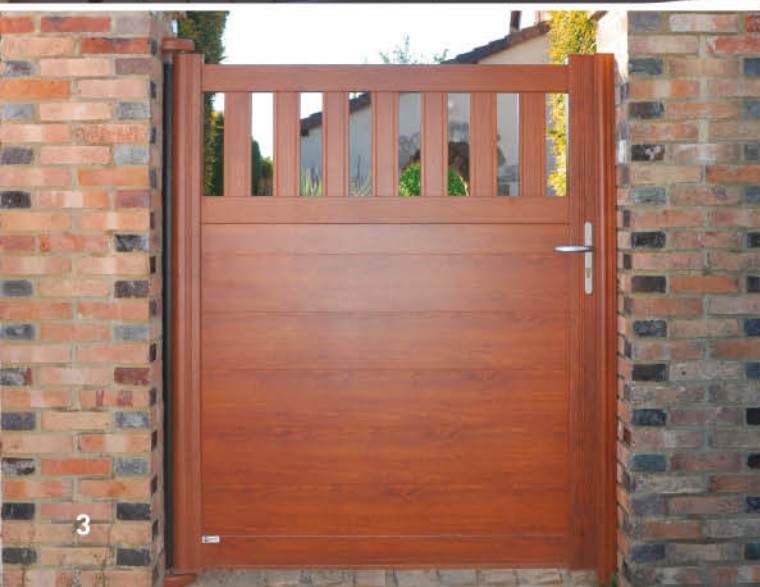

3



4

COLLECTION CLASSIQUE

Des portails indémodables,
aux formes variées.
Simplicité, robustesse et sécurité pour
une collection de portails intemporels.

Légendes

1 - VICTOR HUGO 1

2 - HOICHE 4 : avec clôture et boîte aux lettres

3 - FRIEDLAND : portillon FRIEDLAND 1, chêne doré.

4 - WAGRAM 2 : Portail battant 2 vantaux.

ALU CLASSIQUE





FOCH

PORTAIL / PORTILLON

Ouvertures : battant ou coulissant aspect 1 vantail ou 2 vantaux uniquement sur le modèle 1

Remplissage : Horizontal / Vertical / 45°

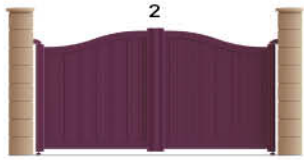
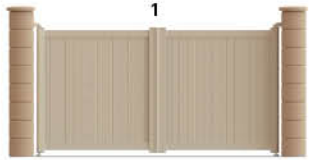

BATTANT
COULISSANT
AUTOPORTANT

KLÉBER

PORTAIL / PORTILLON

Barreaudage : Vertical / Horizontal / Brise vue pour le modèle 1 uniquement

Ouvertures : battant ou coulissant aspect 1 vantail ou 2 vantaux uniquement sur le modèle 1

Remplissage : Horizontal / Vertical / 45°



BATTANT
COULISSANT
AUTOPORTANT

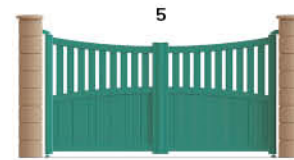
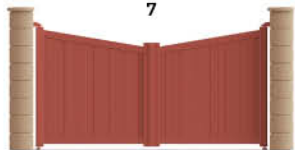
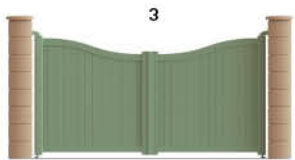

HOCHE

PORTAIL / PORTILLON

Barreaudage : Vertical / Horizontal / Brise vue pour le modèle 1 uniquement

Ouvertures : battant ou coulissant aspect 1 vantail ou 2 vantaux sur tous les modèles

Remplissage : Horizontal / Vertical / 45°

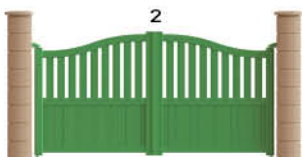
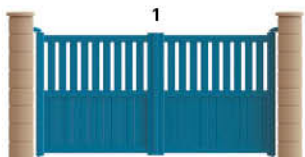

BATTANT
COULISSANT
AUTOPORTANT

IÉNA

PORTAIL / PORTILLON

Ouvertures : battant ou coulissant aspect 1 vantail ou 2 vantaux uniquement sur le modèle 1

Barreaudage : Vertical / Horizontal / Brise vue pour le modèle 1 uniquement

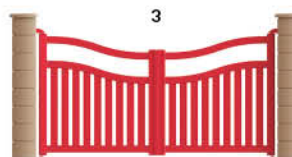
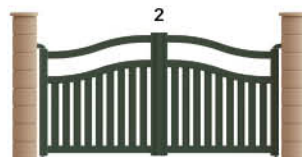

BATTANT
COULISSANT
AUTOPORTANT



HOCHE 7



IÉNA 1 - 1/3 2/3

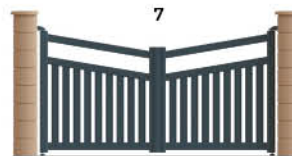
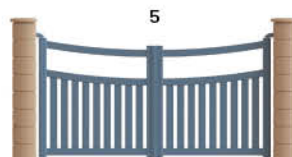
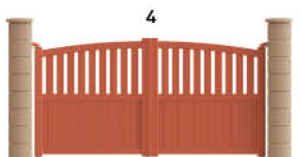



WAGRAM PORTAIL / PORTILLON

Barreaudage : Vertical / Horizontal / Brise vue pour le modèle 1 uniquement

Ouvertures : battant ou coulissant aspect 1 vantail ou 2 vantaux sur tous les modèles

Remplissage : Horizontal / Vertical / 45°



BATTANT
COULISSANT
AUTOPORTANT



WAGRAM 2

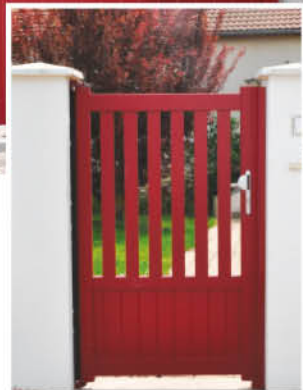

Portillon en harmonie avec le portail



MARCEAU PORTAIL / PORTILLON

Barreaudage : Vertical / Horizontal / Brise vue pour le modèle 1 uniquement

Ouvertures : battant ou coulissant aspect 1 vantail ou 2 vantaux uniquement sur le modèle 1

Remplissage : Horizontal / Vertical / 45°



BATTANT
COULISSANT
AUTOPORTANT



MARCEAU 6



MAC MAHON

PORTAIL / PORTILLON

Ouvertures : battant ou coulissant aspect 1 vantail ou 2 vantaux uniquement sur le modèle 1
Barreaudage : Vertical / Horizontal / Brise vue pour le modèle 1 uniquement



BATTANT
COULISSANT
AUTOPORTANT

VICTOR HUGO

PORTAIL / PORTILLON

Ouvertures : battant ou coulissant aspect 1 vantail ou 2 vantaux uniquement sur le modèle 1
Remplissage : Horizontal / Vertical / 45°

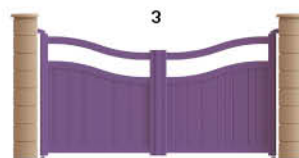
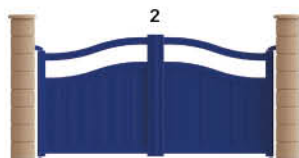

BATTANT
COULISSANT
AUTOPORTANT

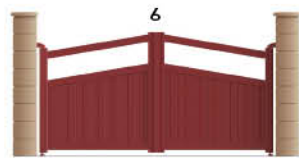
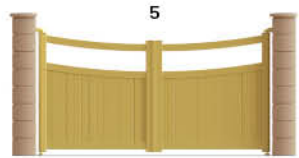
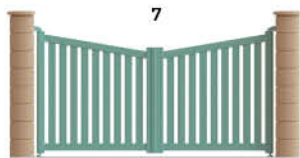
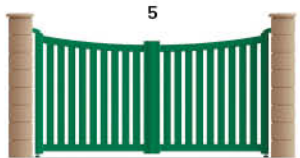
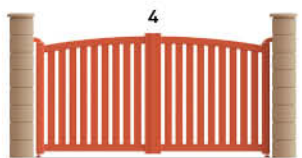



FRIEDLAND

PORTAIL / PORTILLON

Barreaudage : Vertical / Horizontal / Brise vue pour le modèle 1 uniquement

Ouvertures : battant ou coulissant aspect 1 vantail ou 2 vantaux uniquement sur le modèle 1

Remplissage : Horizontal / Vertical / 45°



Bi-couleur
sans plus
value

BATTANT
COULISSANT
AUTOPORTANT

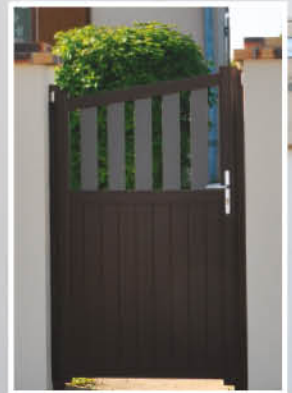

*Portillon en harmonie
avec le portail*



FOCH 2

ALU CLASSIQUE



1



2



3



COLLECTION STYLE

L'Alliance des portails d'autrefois à la légèreté de la matière,
L'harmonie des formes et les nombreux accessoires proposés sauront apporter le style traditionnel et mettre en valeur votre propriété.

Légendes

1 - MÉNILMONTANT 2 : accessoire « boule »
en partie haute

2 - SACRÉ CŒUR 1 : battant

3 - MÉNILMONTANT 2 : portillon

4 - PÈRE LACHAISE 3 : accessoire « pointe »
en partie haute

ALU STYLE





MÉNILMONTANT

PORTAIL / PORTILLON

Ouvertures : 1 vantail / 2 vantaux / 1 Coulissant aspect 1 vantail / Coulissant aspect 2 vantaux

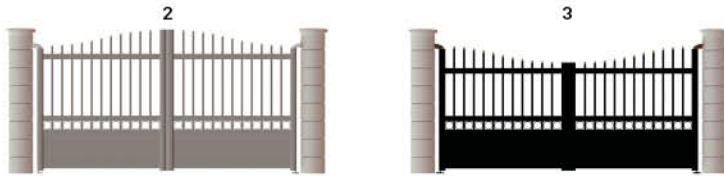

BATTANT
COULISSANT
AUTOPORTANT

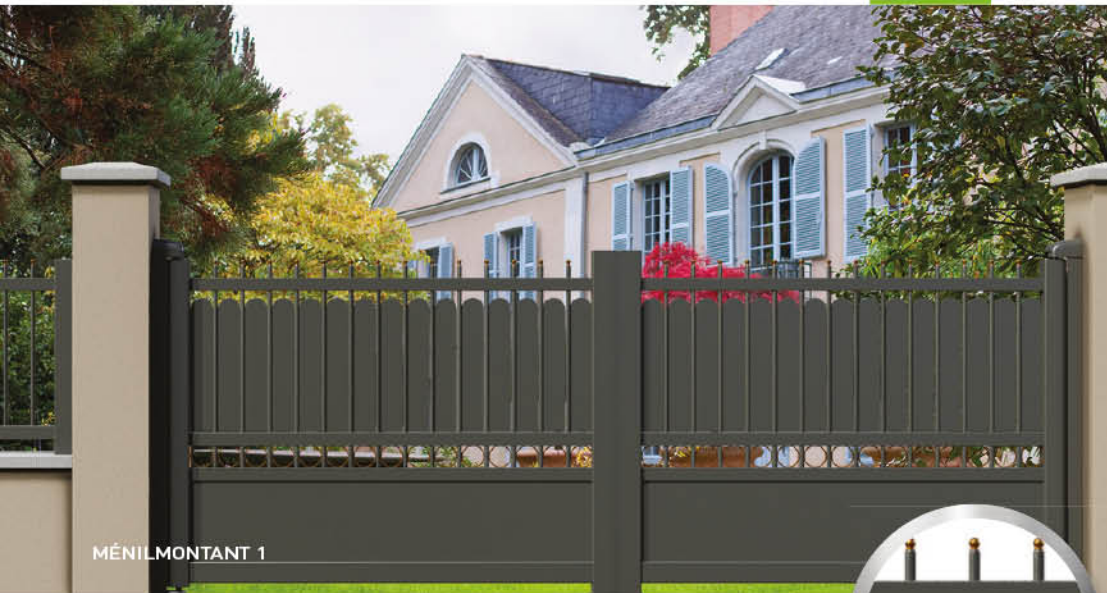

Option festonnage

SACRÉ-CŒUR

PORTAIL / PORTILLON

Ouvertures : 1 vantail / 2 vantaux / 1 Coulissant aspect 1 vantail / Coulissant aspect 2 vantaux

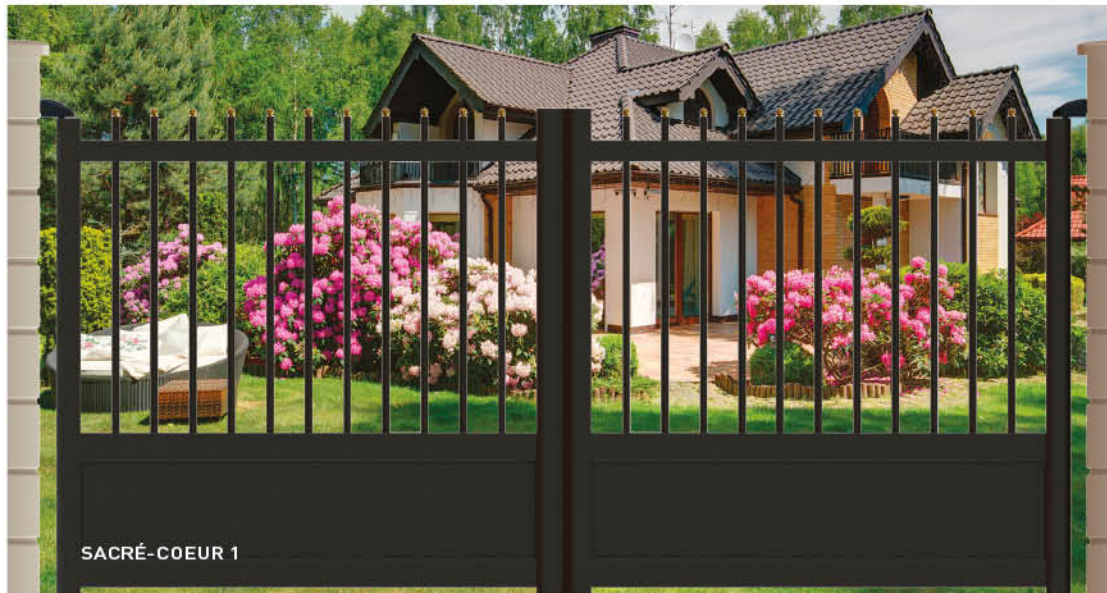
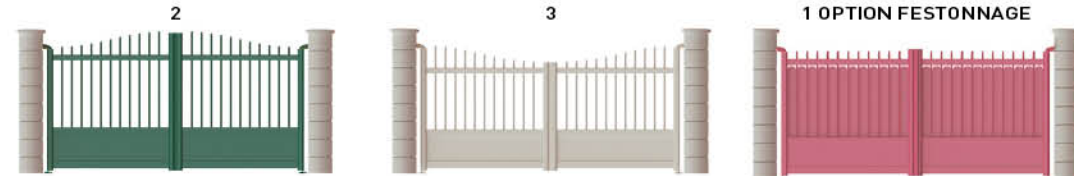

BATTANT
COULISSANT
AUTOPORTANT

PEREIRE

PORTAIL / PORTILLON

Ouvertures : 1 vantail / 2 vantaux / 1 Coulissant aspect 1 vantail / Coulissant aspect 2 vantaux

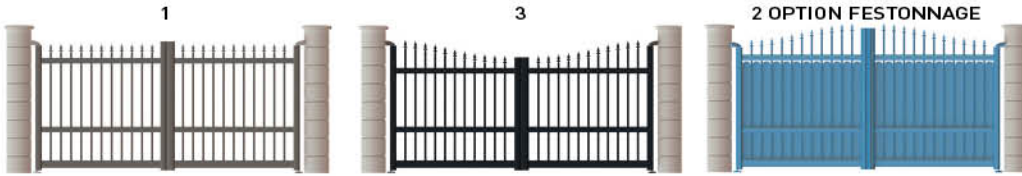

TEMPLE

PORTAIL / PORTILLON

Ouvertures : 1 vantail / 2 vantaux / 1 Coulissant aspect 1 vantail / Coulissant aspect 2 vantaux. Festonnage sur ce modèle non réalisable.



ALU STYLE

BATTANT
COULISSANT
AUTOPORTANT



PEREIRE 2

BATTANT
COULISSANT
AUTOPORTANT

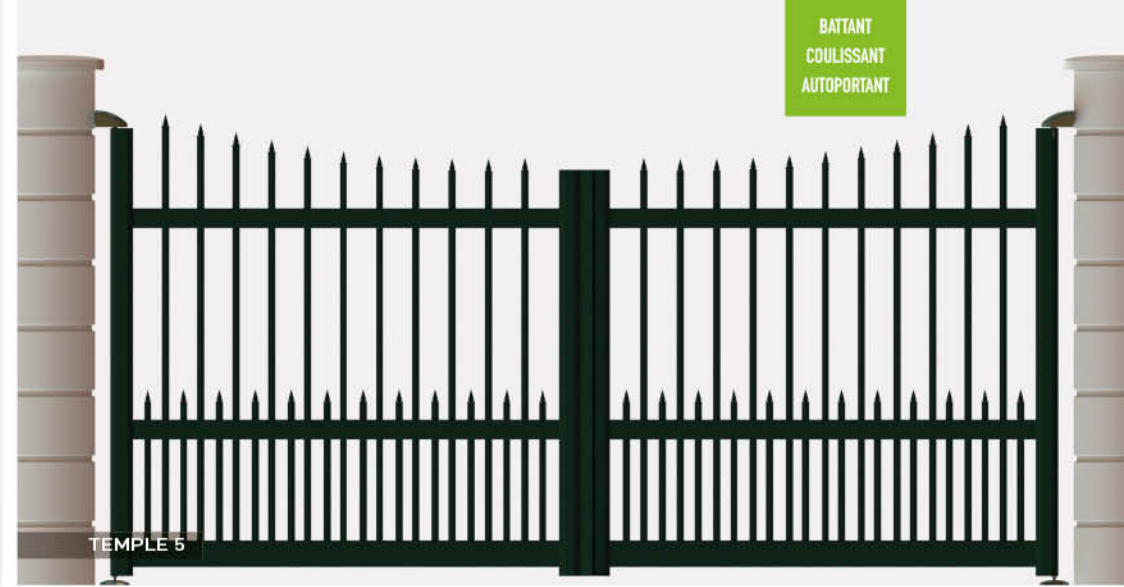

TEMPLE 5



Voir accessoires P. 34

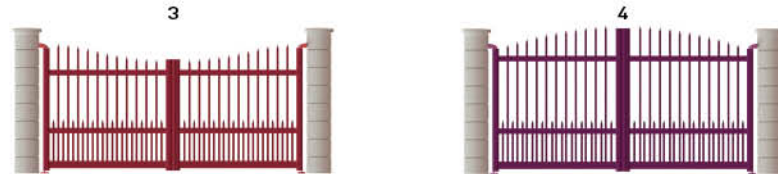



OPÉRA

PORTAIL / PORTILLON

Ouvertures : 1 vantail / 2 vantaux / 1 Coulissant aspect 1 vantail / Coulissant aspect 2 vantaux

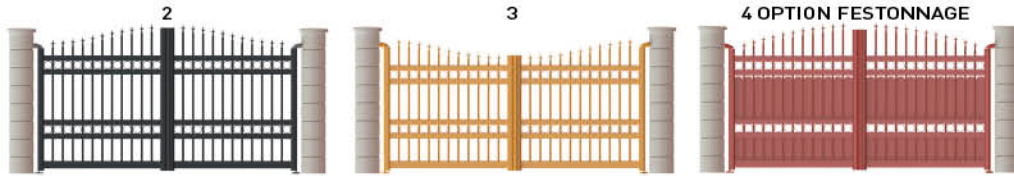

PÈRE LACHAISE

PORTAIL / PORTILLON

Ouvertures : 1 vantail / 2 vantaux / 1 Coulissant aspect 1 vantail / Coulissant aspect 2 vantaux

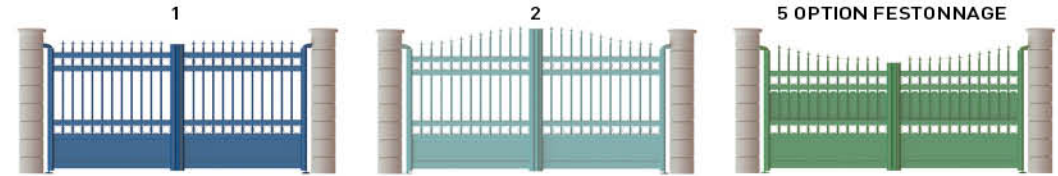

Voir accessoires P. 34



BASTILLE

PORTAIL / PORTILLON

Ouvertures : 1 vantail / 2 vantaux / 1 Coulissant aspect 1 vantail / Coulissant aspect 2 vantaux

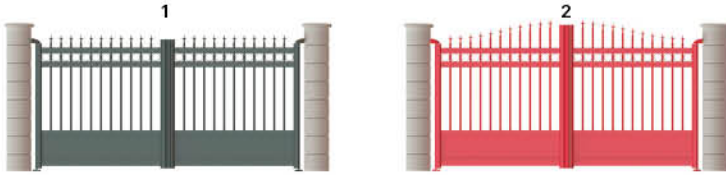

BATTANT
COULISSANT
AUTOPORTANT

PICPUS

PORTAIL / PORTILLON

Ouvertures : 1 vantail / 2 vantaux / 1 Coulissant aspect 1 vantail / Coulissant aspect 2 vantaux.



BATTANT
COULISSANT
AUTOPORTANT

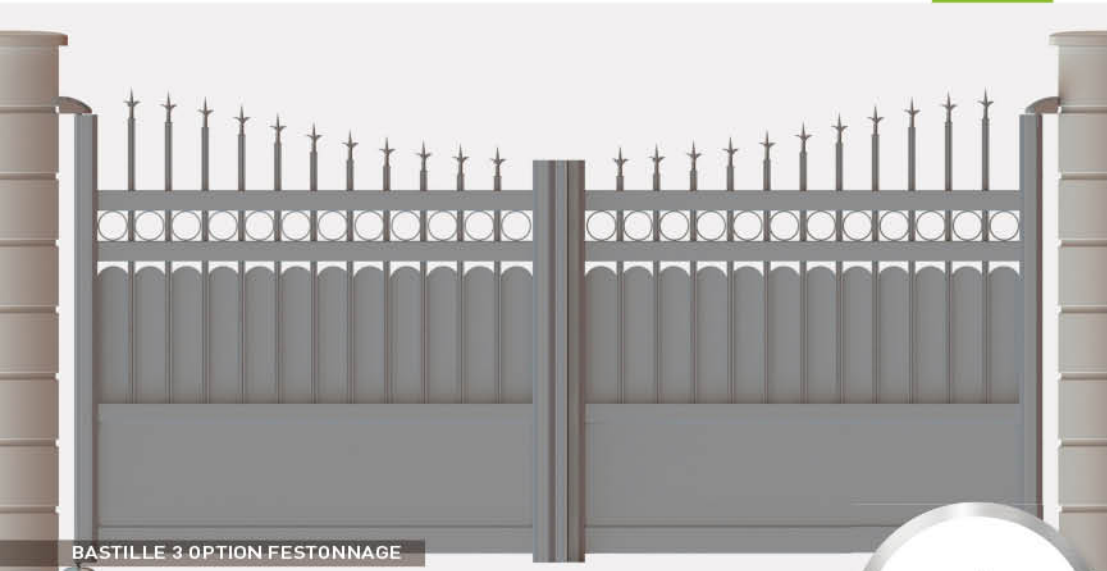

BASTILLE 3 OPTION FESTONNAGE



PICPUS 2

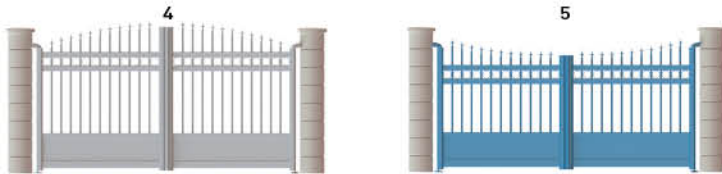

Voir accessoires P. 34



Voir accessoires P.34



2 OPTION FESTONNAGE

Les ACCESSOIRES de DÉCO STYLE

LES ACCESSOIRES

Personnalisez votre portail

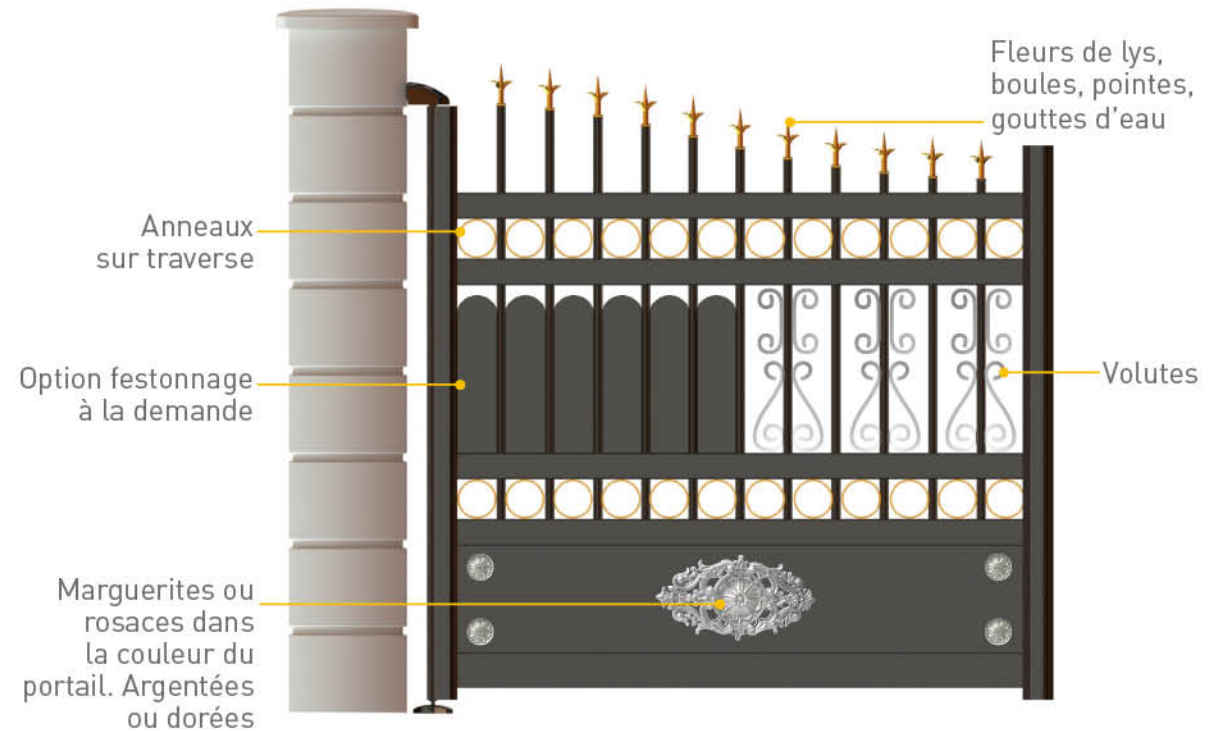
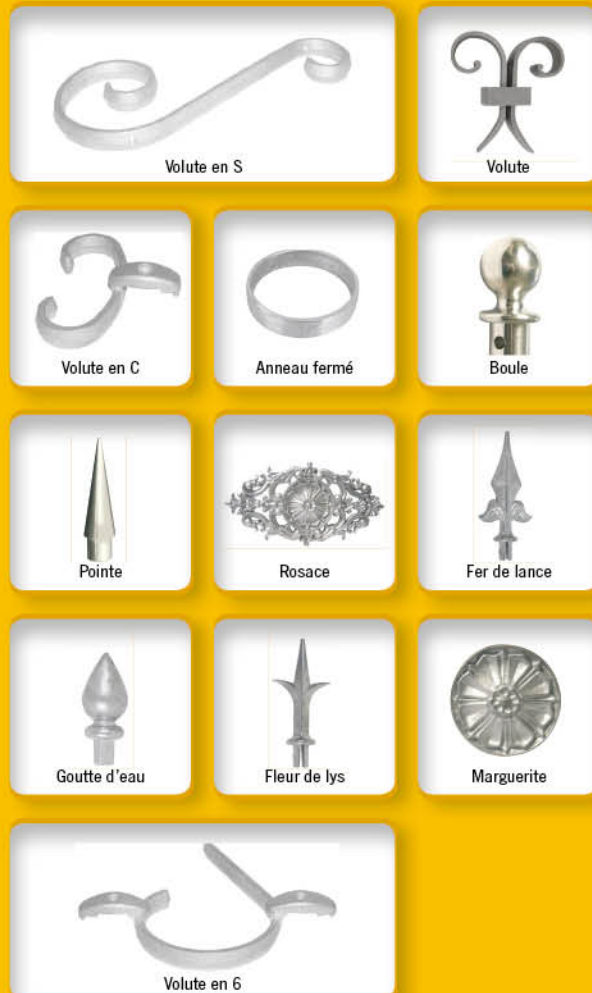

Les différents types d'ouvertures :

- 1 vantail • 2 vantaux • Couissant aspect 1 vantail
- Couissant aspect 2 vantaux - Autoportant



ALU STYLE

MÉNILMONTANT 2
RAL 7042, 7035 bi-coloration

PORTAILS AUTOPORTANTS ALU

PARTICULIER / INDUSTRIE / COLLECTIVITÉ

NOUVEAU

AUTOPORTANT SUR DE NOMBREUX MODÈLES

INFOS techniques

- Largeur maxi entre pilier 4300 mm pour 1 vantail / 8600 mm pour 2 vantaux
- Refoulement de plus 1160 mm pour un passage de 2500 mm entre piliers
- Refoulement de plus 1700 mm pour un passage de 4300 mm entre piliers

Exemples de dimensions de massifs bétons :

- Massif béton pour 2500 mm de passage : Largeur : 500 mm - Profondeur : 800 mm - Longueur : 1750 mm
- Massif béton pour 4300 mm de passage : Largeur : 500 mm - Profondeur : 800 mm - Longueur : 2290 mm
- Hauteur sous la poutre du portail environ 80 mm

Maximum 4 300 mm entre piliers. Si ouverture supérieure à 4 300 mm prévoir deux portails autoportants.

Exemple de réalisation
avec deux autoportants
(8 000 mm de passage)



Pratique, aucun
rail au sol



Ouverture rapide
et motorisable



Poutre
porteuse



Double platine
de guidage



Guidage par 2 chariots
vissés sur un massif béton

PVC *CADRE ALU INTÉGRÉ*





PRÉ-CATELAN

PORTAIL / PORTILLON

Ouvertures : battant ou coulissant aspect 1 vantail ou 2 vantaux uniquement sur le modèle 1

Remplissage : Horizontal / Vertical / 45°



BATTANT
COULISSANT



PRÉ-CATELAN 1

VERT GALANT

PORTAIL / PORTILLON

Ouvertures : battant ou coulissant aspect 1 vantail ou 2 vantaux uniquement sur le modèle 1

Barreaudage : Vertical / Horizontal



BATTANT
COULISSANT



VERT GALANT 3

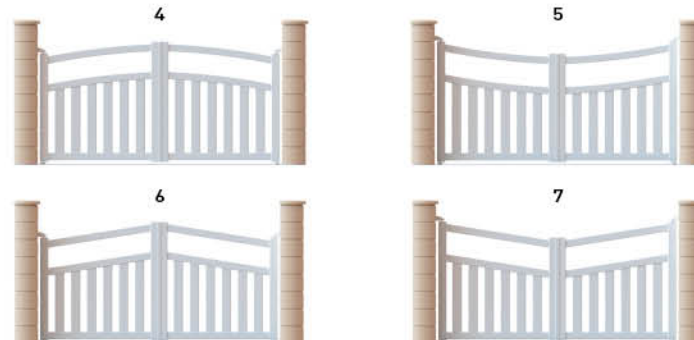
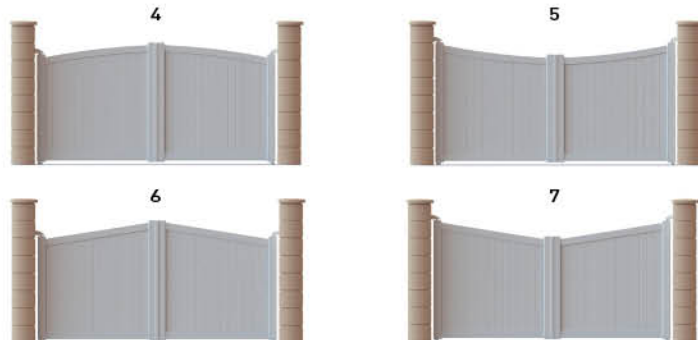

BUTTES CHAUMONT

PORTAIL / PORTILLON

Ouvertures : battant ou coulissant aspect 1 vantail ou 2 vantaux uniquement sur le modèle 1

Barreaudage : Vertical / Horizontal

Remplissage : Horizontal / Vertical / 45°



BATTANT
COULISSANT

TROCADÉRO

PORTAIL / PORTILLON

Ouvertures : battant ou coulissant aspect 1 vantail ou 2 vantaux uniquement sur le modèle 1

Barreaudage : Vertical / Horizontal

Remplissage : Horizontal / Vertical / 45°



BATTANT
COULISSANT

PVC Cadre alu intégré



BUTTES CHAUMONT 6

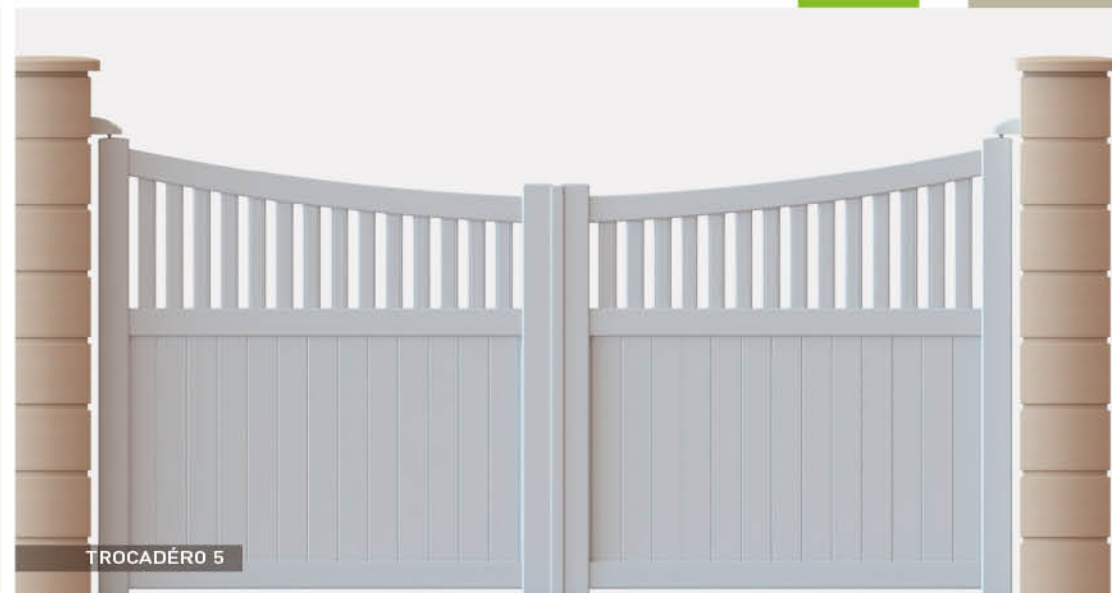

TROCADÉRO 5





MONTSOURIS

PORTAIL / PORTILLON

Barreaudage : Horizontal, vertical

Ouvertures : battant ou coulissant aspect 1 vantail ou 2 vantaux uniquement sur le modèle 1

Remplissage : Horizontal, vertical ou 45°



BAGATELLE

PORTAIL / PORTILLON

Barreaudage : Horizontal, vertical

Ouvertures : battant ou coulissant aspect 1 vantail ou 2 vantaux uniquement sur le modèle 1

Remplissage : Horizontal, vertical ou 45°



MONCEAU

PORTAIL / PORTILLON

Ouvertures : battant ou coulissant aspect 1 vantail ou 2 vantaux uniquement sur le modèle 1
Barreaudage : Horizontal, vertical



BATTANT
COULISSANT



MONCEAU 1



LUXEMBOURG

PORTAIL / PORTILLON

Ouvertures : battant ou coulissant aspect 1 vantail ou 2 vantaux uniquement sur le modèle 1
Remplissage : Horizontal, vertical ou 45°



BATTANT
COULISSANT



LUXEMBOURG 3





DAUPHINE

PORTAIL / PORTILLON

Barreaudage : Horizontal, vertical

Ouvertures : battant ou coulissant aspect 1 vantail ou 2 vantaux uniquement sur le modèle 1

Remplissage : Horizontal, vertical ou 45°



BATTANT
COULISSANT



DAUPHINE 1

CLAUSTRAS Jardin & terrasse



**imaginez
votre claustra !**
un grand choix de
décors pour embellir
vos espaces



UN DESIGN CONTEMPORAIN, CLASSIQUE OU INSPIRÉ PAR LA NATURE

Discrète et affirmée, la gamme de claustra s'harmonise avec tous les styles architecturaux et toutes les envies de vos clients.

CLAUSTRA SUR MESURE PERSONNALISABLE

Que vous souhaitiez délimiter, créer un espace, préserver des intérieurs, les claustras GP PORTAIL répondent aux besoins de vos clients. Des décors sont disponibles en standard ou sur mesure.



CLÔTURES ALU SANS TRAVERSE

NOUVEAU

GP PORTAIL innove et crée une gamme de 4 clôtures au remplissage design, aérien, jointif ou brise-vue de haute qualité, dotées d'un système d'assemblage innovant déclinable dans tous nos coloris.

BERCY



Remplissage barreaux 200 mm « design » (ajouré 20 mm)

CADET



Remplissage barreaux 200 mm « jointif »

LIBERTÉ



Remplissage barreaux de 90 mm « aérien »

AVRON

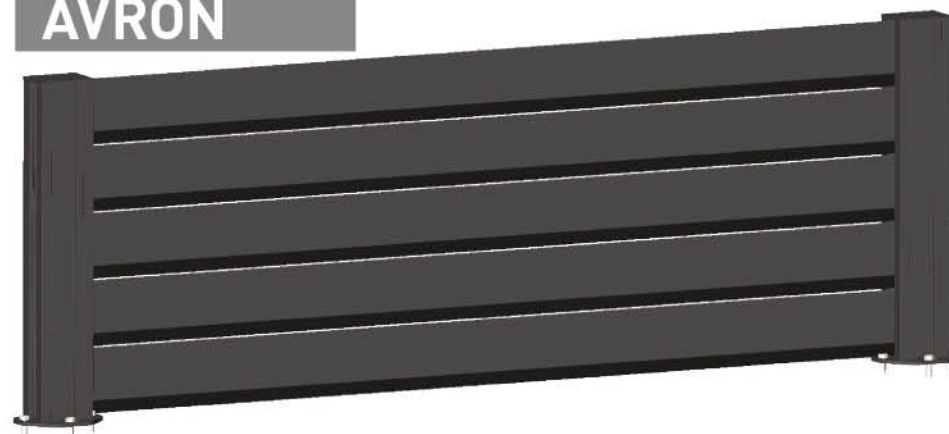

Remplissage « brise-vue »

POTEAU CLÔTURE SANS TRAVERSE

CLÔTURES PVC SANS TRAVERSE

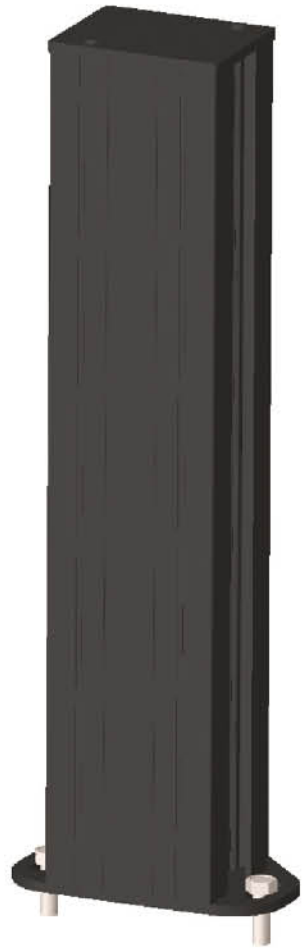

Poteau alu 84 X 64 mm, avec platine

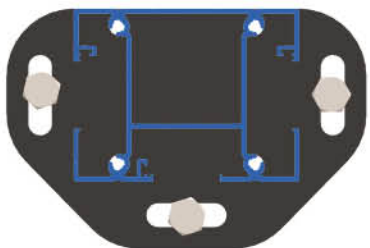

RIVOLI



- Clôture lame brisée
- Vue 28X130 mm avec jour de 25 mm
- Livré en kit
- Hauteur standard

JOURDAIN



- Clôture ajourée barreaudage
- 100X24 mm
- Livré en kit

PERNETY



- Lisse 150X24 mm
- Livré en panneaux assemblés
- Finition avec profilé de 24X18 mm

Poteau et demi poteau clôture PVC SANS TRAVERSE



- Poteau 96X96 mm avec platine acier à visser



- 1/2 poteau de départ et d'arrivée
96X40 mm à visser sur maçonnerie



CLÔTURES DESIGN et CLASSIQUE

Nos gammes de clôtures, également réalisées en aluminium ou PVC sont en harmonie avec tout nos modèles de portails et portillons des gammes DESIGN, CLASSIQUE ET PVC



MAGENTA / ALU



CONCORDE / ALU

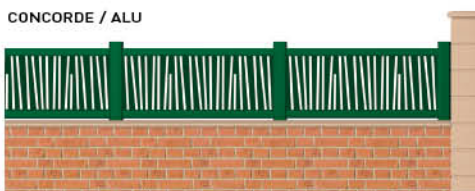

IÉNA / ALU



VERT GALANT / PVC

FOCH / ALU



PRÉ-CATELAN / PVC

WAGRAM / ALU

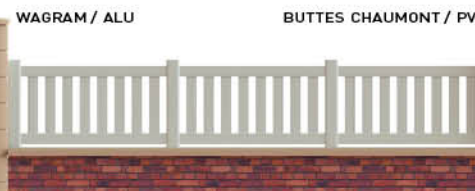

BUTTES CHAUMONT / PVC

CARNOT / ALU



ODÉON / ALU (visuel option tôle)

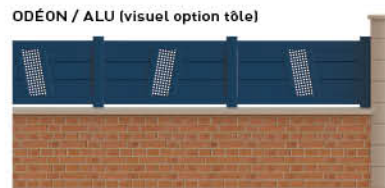

GAÏTE / ALU



MAC MAHON / ALU



RASPAIL / ALU

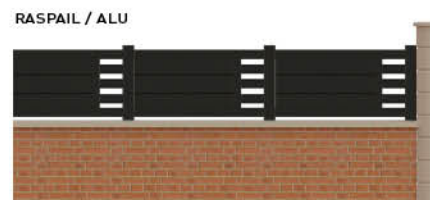

VICTOR HUGO / ALU LUXEMBOURG / PVC

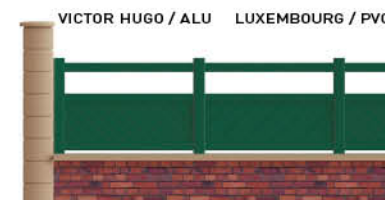

CLÔTURES Alu *Style*

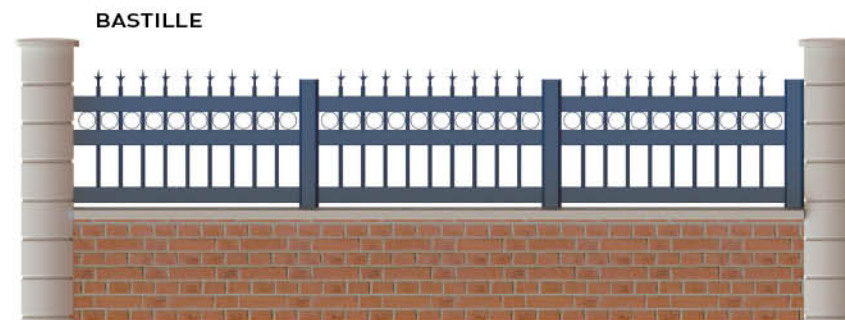
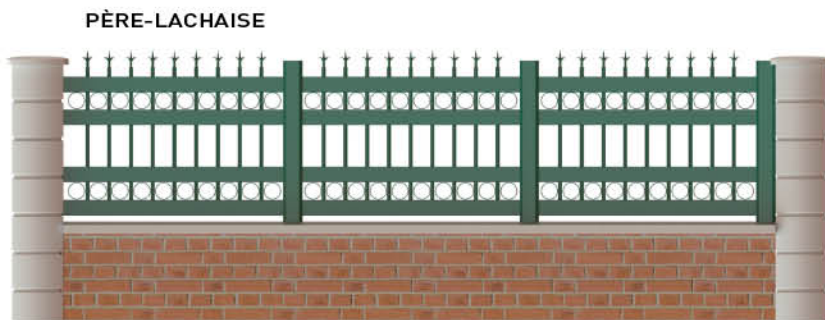
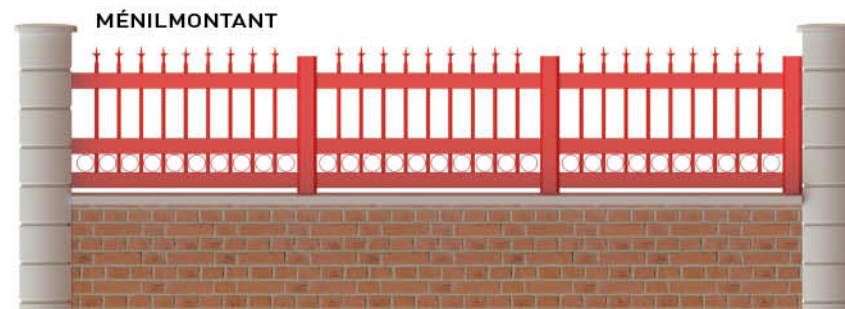
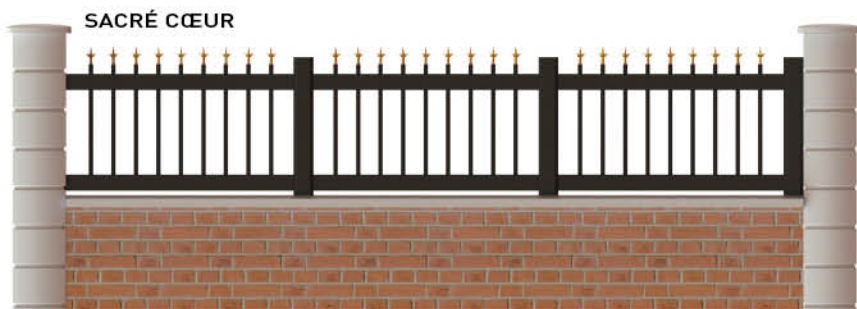

*Portillon MÉNILMONTANT 2
en harmonie
avec le portail
P. 32*

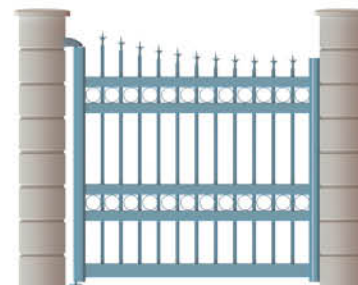

*Portillon OPÉRA 5
en harmonie
avec le portail
P. 34*

GARDE-CORPS *et* RAMPES



CONVENTION
Barreaudage sous la lisse intermédiaire



DAUMESNIL
Barreaudage sous la main courante



DIMENSIONS MAXI ENTRE POTEAUX (mm)

1000 mm pour les lieux publics
1500 mm pour les lieux privés

CAMBRONE
Bande fitante version paquebot



CLUNY
Bande fitante sous la lisse avec remplissage verre

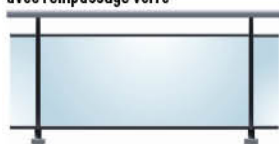

MIRABEAU
Remplissage verre sous la main courante



DESIGN

Design DROIT, finitions soignées (système de fixation parfaitement dissimulé par un cache en aluminium laqué à la teinte du sabot).



Sécurisez et embellissez vos espaces

UN DESIGN SUBTIL & ÉPURÉ

Sécuriser vos balcons, escaliers,...
Discret et affirmé, classique ou
contemporain, notre gamme de garde-
corps s'harmonise avec tous les styles
architecturaux et toutes vos envies.

SÉCURITÉ

Conforme aux normes NF P 01-012 et NF
P 01-013. Essais réalisés par le CEBTP
(Conformément aux exigences
de la norme NF P 01-013).



SABOTS

Divers modèles de
sabots s'adaptent à
tous types de pose.
Possibilité de laquer la
plupart des accessoires
visibles à la couleur du
garde-corps. Pièces de
liaison en inox ou en
alu. Toute la visserie
est en inox.

Pose sur dalle



Pose de face



BARREAU

- Rectangulaire
17,5 x 25 mm



UN NUANCIER
DE 236 COULEURS
disponibles
de garde-corps
assorties au portail
+ Chêne antique

236
COULEUR

RAMPES

Des formes droites,
fines et contemporaines,
des embouts laqués
à chaque coupe.
*l'élégance
au rendez-vous !*



COTES DES PROFILS

- Main courante : 50 x 20 mm
85 x 34,2 mm si vitrage toute hauteur
- Poteau : 40 x 20 mm
- Barreau : 25 x 15,5 mm
- Vitrage feuilleté : 44²

STYLES

Droit, rampant, en
remplissage ou en
barreaudage...

*imaginez votre
garde-corps !*

LUMIÈRE

Rajoutez des **strip led**
sur votre garde-corps.
Ambiance assuré !



DES TEINTES à l'infini...

Les couleurs alu 200 teintes disponibles 13 couleurs en standard / 3 en option
Bi-coloration avec teintes en standard sans plus-value

RAL STANDARD ALU



Couleurs PVC
 4 teintes disponibles
 Le blanc en standard
 3 en option

EN OPTION

NOUVELLES COULEURS!



PVC

EN OPTION



DÉCOR perforées et inserts alu



A



B

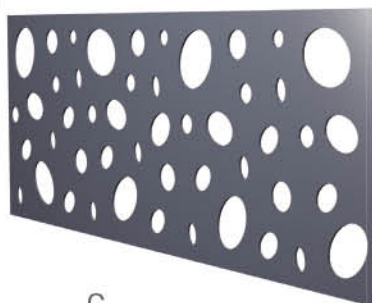

C

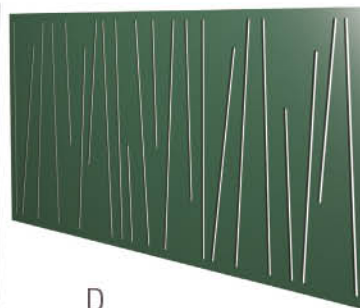

D

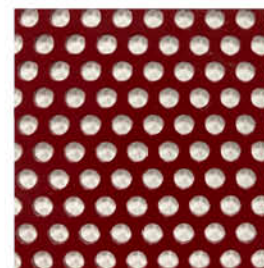

I

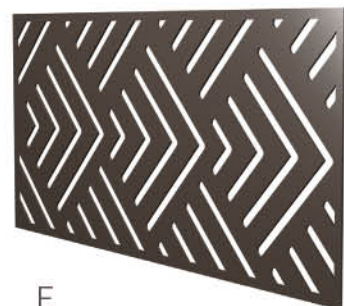

E

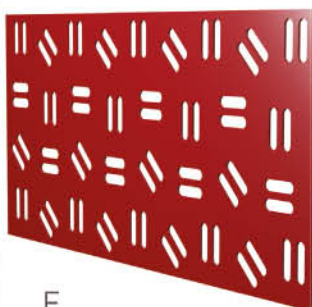

F



G

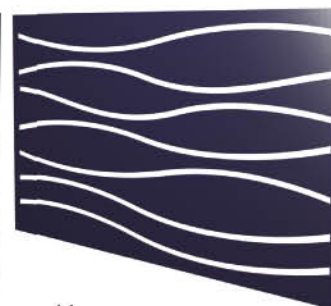

H

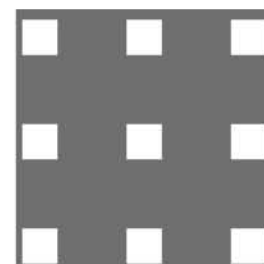

J

LES DÉCORS SUR-MESURE

Envie de personnaliser votre portail avec un décor personnel, notre designer le modélise et le réalise pour vous.



NOUVEAU



K - Alu brossé
ALESIA



L - Décor alu et PMMA 2 faces
MIROMESNIL



M - Décor alu et PMMA 2 faces
MIROMESNIL

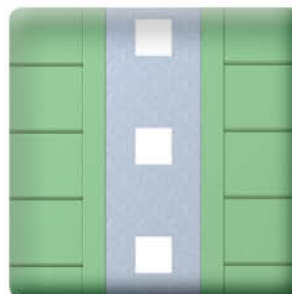

N - Décor alu et PMMA 2 faces
MIROMESNIL



O - Alu brossé
TOLBIAC



P - Alu brossé
TOLBIAC

Les possibilités de **REMPLISSAGES**



*Barreaudage vertical, horizontal ou 45°
70, 90 et 200 mm*



*Remplissage tôle perforée
rond (Ø 5 mm)*



*Remplissage lame classique 95 mm
fougère 45°, horizontale ou verticale*



*Remplissage lame design
horizontale ou verticale 185 mm*



Brise vue horizontal ou vertical



Décor insert alu



Décor tôle perforée

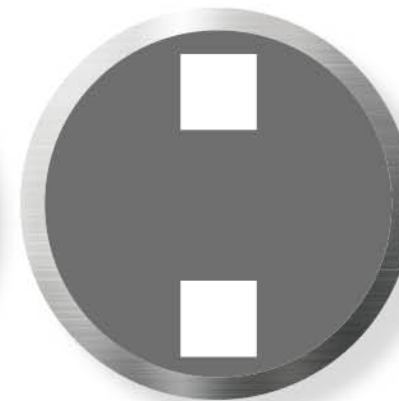

*Remplissage tôle perforée
carré (10 mm)*

PROFILÉS



Barreau 90 mm
pour clôture et portail

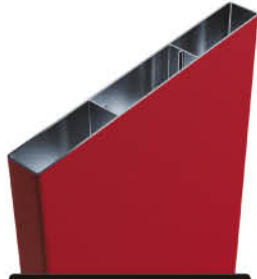

Barreau 200 mm
pour clôture et portail

Lame 185 mm
pour clôture et portail

Pas de 95 mm classique
pour clôture et portail



Lame brise-vue
pour clôture et portail

GOND CACHE VUE

Composé d'un gond, d'un capot et d'un profilé en alu de masquage entre le montant et le pilier, le gond cache vue est esthétique.

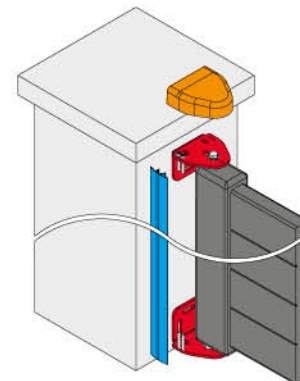
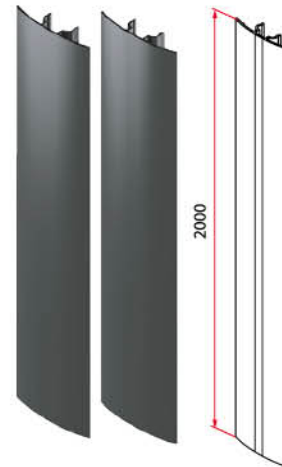

Réglage

Gond réglable sur 3 axes avec une course de 25 mm. Pivot excentrique (Ø12 mm) permettant de régler l'aplomb (7 mm) du portail.

Finition

Embase en acier zingué + poudré. Carénage et profil de masquage en aluminium, à clipser et réversible.



LES ACCESSOIRES INDISPENSABLES

LES TYPES



GOND INOX
à visser 1 point caréné noryl



GOND INOX
à scellement chimique
caréné noryl



POIGNÉES BÂTON INOX



GOND INOX
à visser 3 points caréné alu



GOND INOX
à visser 2 points caréné noryl



PAUMELLE INOX
caréné noryl 180° (uniquement portail alu)



SABOT AUTOMATIQUE ALU



SABOT COMPOSITE



VARIAPENTE INOX
caréné noryl (uniquement portail alu)



RAILS DE SEUIL
à visser pour portail
coulissant longueur 3 ml



CRAPAUDINE INOX



SABOT INOX

Poteau multidirectionnel
3D ALU 105 x 105

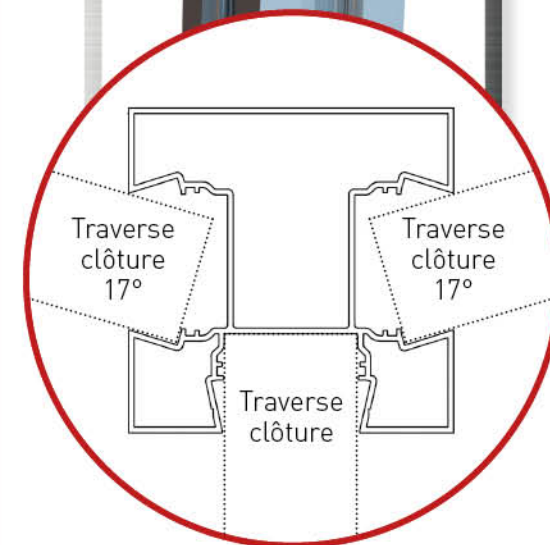



- 1 - Poteau ALU 230 x 230
scellement de 500 mm
- 2 - Poteau ALU 180 x 180
scellement de 500 mm
- 3 - Poteau ALU 105 x 105
scellement de 500 mm
- 4 - Poteau ALU sur platine
pour portail coulissant
et battant 180 x 180
Dimensions platine :
180 x 280 x 10 mm

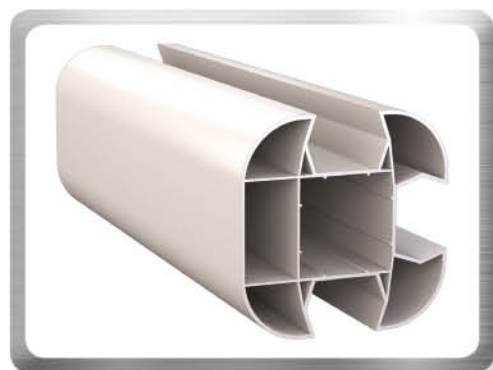

Poteau clôture PVC Éco 96 x 96
Poteau 96 X 96 mm avec platine
acier à visser

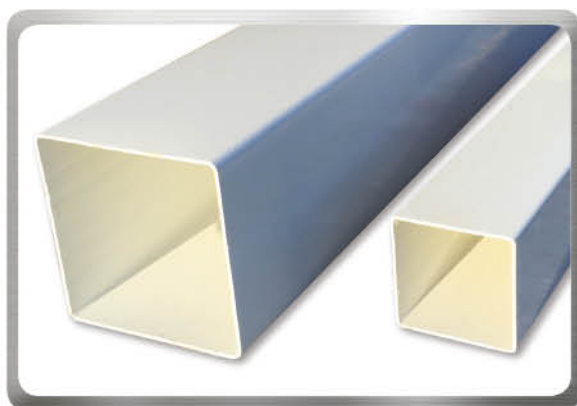

Poteau PVC 120 x 120 scellement de 500 mm
Poteau PVC 200 x 200 scellement de 500 mm

Types d'ouvertures

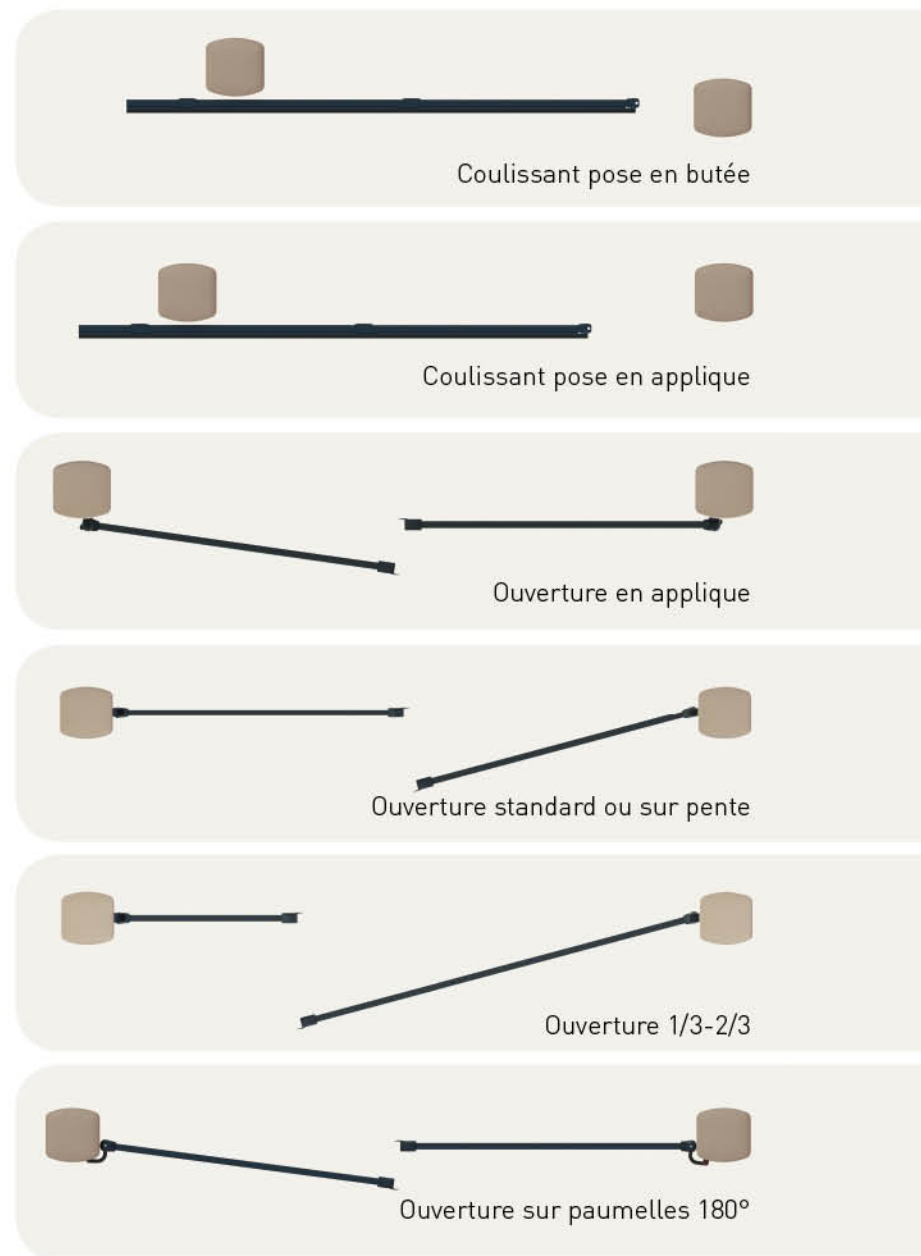

LA MOTORISATION ET LES ACCESSOIRES

MOTORISATION INTÉGRÉE pour une esthétique optimale



INVISIO
Moteur intégré pour portail battant

INVISIBLE !
moteur intégré dans le battant

- 1 Capot
- 2 Pivot (ouverture à plat)
- 3 coupelle et joints
- 4 Plaque de fixation moteur
- 5 moteur
- 6 Profilé aluminium
- 7 Plaque crapaudine
- 8 serre-tube et bague nylon
- 9 crapaudine (ouverture à plat)

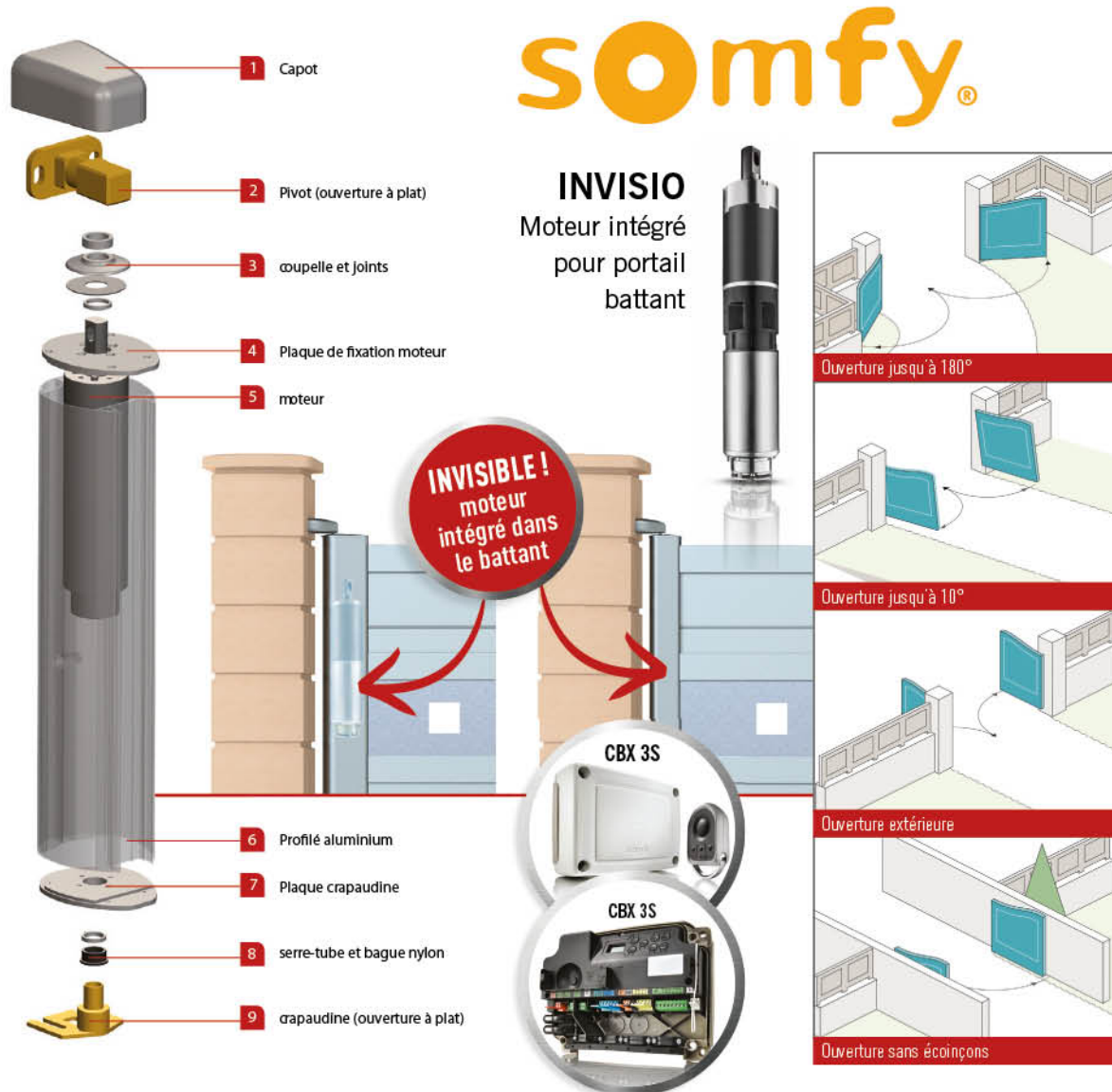

CBX 3S

CBX 3S

Ouverture jusqu'à 180°

Ouverture jusqu'à 10°

Ouverture extérieure

Ouverture sans écoinçons

SOLUTIONS D'



AXOVIA 220B CONFORT RTS
Motorisation à bras portail < 4m



AXOVIA MULTI PRO POUR OUVERTURE EXT.
motorisation à bras pour portail < 4m en ouverture vers l'extérieur



AXOVIA 3S IO
Motorisation à bras portail < 4m



FABRICANT LABELLISÉ PBS



IXENGO L PRO
Motorisation à vérins portail < 6m



ELIXO 500
Motorisation pour portail coulissant < 8 m



ELIXO SMART IO
Motorisation pour portail coulissant < 6m



AXOVIA MULTI PRO BRAS STANDARD
motorisation à bras portail < 5m



AXOVIA MULTI PRO BRAS GLISSIERE
motorisation à bras pour ouverture jusqu'à 150° ou faibles écoinçons

Les moteurs de la gamme SOMFY sont en IO ou RTS.  

CONNECTÉS POUR VOTRE CONFORT

INTERPHONIE et de MOTORISATION CONNECTÉES



BOX SOMFY CONNEXOON

Connectez et pilotez votre portail grâce aux applis. Compatible avec les équipements io-homecontrol, disponible sur smartphone Android et IOS



VISIOPHONE V500 PRO IO

Ecran tactile 7" avec mémorisation d'images, affichage des température ext. et int., pilotage gâche électrique, portail en filaire, Pilotage 5 produits



BOITIER TAHOMA LIBERTÉ

1 Boitier Tahoma + 1 Cable ethernet + 1 Adaptateur secteur



LIVI 502

motorisation à bras portail $< 6m$



STING

motorisation à vérin portail $< 6m$



KIT VIDEA 100

Ecran 7" pilotage du portail en filaire



ANGOLO

motorisation à bras portail $< 4m$ faible encombrement



LOOK

motorisation à vérin $< 7m$



KIT VIDEA 100 K

Ecran 7" pilotage du portail en filaire digicode intégré



AXOVIA MULTI PRO POUR PENTE

motorisation à bras pour portail équipé de gonds de régulation de pente



ROLLY SMART IO

motorisation intégrée coulissant



GEKO

motorisation à bras portail $< 4m$



LIVI N

Motorisation portail coulissant

DEA



PORTAILS ALU DESIGN BATTANTS, COULISSANTS, AUTOPORTANTS

ALÉSIA P. 10		COULISSANT 1 VTL ET 2 VTX MODÈLES 1 À 7
BEL-AIR P. 12		COULISSANT 1 VTL ET 2 VTX MODÈLES 1 À 7
BOLIVAR P. 16		COULISSANT 1 VTL MODÈLE 1 2 VTX MODÈLES 1 À 7
CARNOT P. 17		COULISSANT (SAUF MODÈLE 3) 1 VTL MODÈLE 6 ET 7 2 VTX MODÈLES 1 À 7
CONCORDE P. 11		COULISSANT 1 VTL JUSQU'À 3 M ET 2 VTX MODÈLES 1 À 7
COURCELLES P. 13		COULISSANT 1 VTL MODÈLE 1 2 VTX MODÈLE 1
DUPLEIX P. 09		COULISSANT 1 VTL ET 2 VTX MODÈLES 1 À 7
GAÏTÉ P. 15		COULISSANT 1 VTL ET 2 VTX MODÈLES 1 À 7
JASMIN P. 14		COULISSANT 1 VTL ET 2 VTX MODÈLES 1 À 7
JUSSIEU P. 16		COULISSANT 1 VTL ET 2 VTX MODÈLES 1 À 7

PORTAILS ALU DESIGN BATTANTS, COULISSANTS, AUTOPORTANTS

MABILLON
P. 08

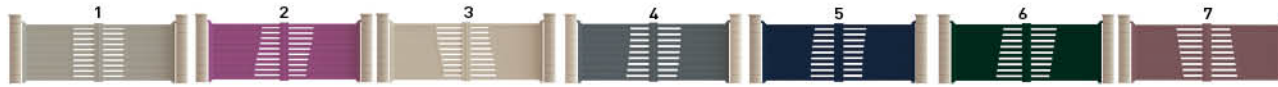

COULISSANT
1 VTL ET 2 VTX
MODÈLES 1 À 7

MAGENTA
P. 10

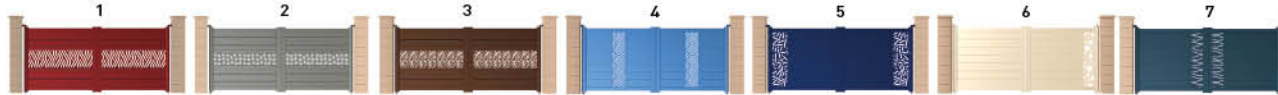

COULISSANT
1 VTL MODÈLES
1/2/3 JUSQU'À 3 M ET
2 VTX MODÈLES 1 À 7

MIROMESNIL
P. 11

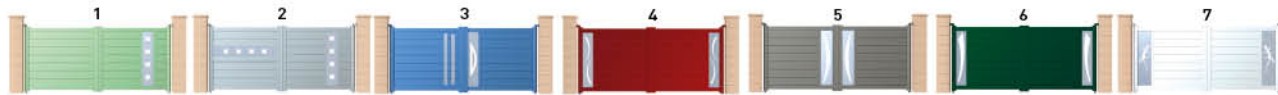

COULISSANT
1 VTL ET 2 VTX
MODÈLES 1 À 7

ODÉON
P. 14

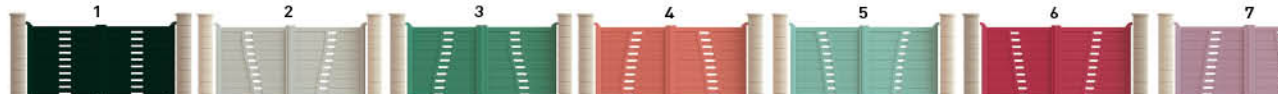

COULISSANT
1 VTL ET 2 VTX
MODÈLES 1 À 7

PASSY
P. 12



COULISSANT
1 VTL ET 2 VTX
MODÈLES 1 À 7

PASTEUR
P. 13



COULISSANT
1 VTL ET 2 VTX
MODÈLES 1 À 7

PYRAMIDES
P. 09



COULISSANT
1 VTL MODÈLES 4 ET 5
2 VTX MODÈLES 1 À 5

RASPAIL
P. 18



COULISSANT
1 VTL ET 2 VTX
MODÈLES 1 À 7

SÉGUR
P. 17



COULISSANT
2 VANTAUX
UNIQUEMENT

TOLBIAC
P. 08



COULISSANT
1 VTL ET 2 VTX
MODÈLES 1 À 7

VANEAU
P. 15



COULISSANT
1 VTL ET 2 VTX
MODÈLES 1 À 7

PORTAILS ALU CLASSIQUE BATTANTS, COULISSANTS, AUTOPORTANTS

FOCH P. 22								COULISSANT 1 VTL MODÈLE 1 2 VTX MODÈLES 1 À 7
FRIEDLAND P. 26								COULISSANT 1 VTL MODÈLE 1 2 VTX MODÈLES 1 À 7
HOCHE P. 23								COULISSANT 1 VTL MODÈLE 1 2 VTX MODÈLES 1 À 7
IÉNA P. 23								COULISSANT 1 VTL MODÈLE 1 2 VTX MODÈLE 1
KLÉBER P. 22								COULISSANT 1 VTL MODÈLE 1 2 VTX MODÈLE 1
MAC MAHON P. 25								COULISSANT 1 VTL MODÈLE 1 2 VTX MODÈLES 1 À 7
MARCEAU P. 24								COULISSANT 1 VTL MODÈLE 1 2 VTX MODÈLE 1
VICTOR HUGO P. 25								COULISSANT 1 VTL MODÈLE 1 2 VTX MODÈLE 1
WAGRAM P. 24								COULISSANT 1 VTL MODÈLE 1 2 VTX MODÈLES 1 À 7

PORTAILS ALU STYLE BATTANTS, COULISSANTS

BASTILLE
P. 33



MÉNILMONTANT
P. 30



OPÉRA
P. 32



PEREIRE
P. 31



PÈRE-LACHAISE
P. 32



PICPUS
P. 33



SACRÉ-CŒUR
P. 30



TEMPLE
P. 31



PORTAILS PVC BATTANTS, COULISSANTS

BAGATELLE P. 40		COULISSANT 1 VTL MODÈLE 1 2 VTX MODÈLE 1
BUTTES CHAUMONT P. 39		COULISSANT 1 VTL MODÈLE 1 2 VTX MODÈLES 1 À 7
DAUPHINE P. 42		COULISSANT 1 VTL MODÈLE 1 2 VTX MODÈLES 1 À 7
LUXEMBOURG P. 41		COULISSANT 1 VTL MODÈLE 1 2 VTX MODÈLE 1
MONCEAU P. 41		COULISSANT 1 VTL MODÈLE 1 2 VTX MODÈLES 1 À 7
MONTSOURIS P. 40		COULISSANT 1 VTL MODÈLE 1 2 VTX MODÈLE 1
PRÉ CATELAN P. 38		COULISSANT 1 VTL MODÈLE 1 2 VTX MODÈLES 1 À 7
TROCADÉRO P. 39		COULISSANT 1 VTL MODÈLE 1 2 VTX MODÈLES 1 À 7
VERT-GALANT P. 38		COULISSANT 1 VTL MODÈLE 1 2 VTX MODÈLE 1

ÉLÉMENTS COMPRIS DANS LE PORTAIL



Battant

Coulissant



Gonds 2 points / Crapaudine / Sabot composite /
Serrure 5 clés / Double béquille
Plaque de propreté

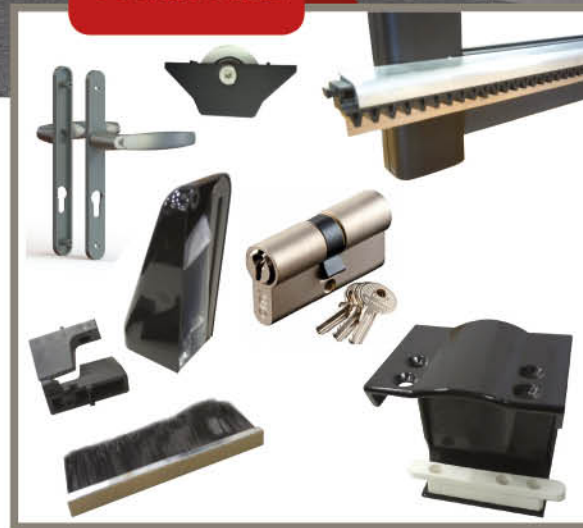

Platine de guidage / Gâche de réception / Support
roulette avec sa roulette inox / Serrure 5 clés / Double
béquille / Crémaillère et son cache en option

BOITE AUX LETTRES ET NUMÉRO ALU BROSSÉ



Boîte aux lettres normalisée, intégrée à la couleur du portail.

Dimensions : L : 282 mm x H : 285 mm x P : 410 mm

Double ouverture, face intérieure et extérieure. Installation facile



Numéro alu brossé rétroéclairé

**Exclusivité
GP Portail**



GP PORTAIL C'EST :

- LA ROBUSTESSE
- GARANTIE 25 ANS¹
- DES PRODUITS ÉCO-CONÇUS 
- UNE GAMME COMPLÈTE
Alu design, Alu classique,
Alu style, PVC

 Fabrication française

 Qualité ISO 9001

 Design personnalisé

 Rapport qualité prix

 Délai respecté



VOTRE DISTRIBUTEUR



PORTAILS ALU ET PVC, UNE GAMME COMPLÈTE FABRIQUÉE EN FRANCE 